

25c [30c in Canada]

APRIL, 1934

\$3.00 PER YEAR BY SUBSCRIPTION

RADIO

ESTABLISHED 1917

SHORT-WAVE AND EXPERIMENTAL

- IN THIS ISSUE -

The A to Z of Link Coupling
 An Electron-Coupled Newcomer's Transmitter
 A Mixer Monitor for C. W. and Phone
 Converting the S-W-3 Into a Super-Het
 Some Reports on the International Tests



Guy Hutcheson, Radio Operator on the "Jacob Ruppert," tuning the big 20B, 1,000 watt Collins transmitter in the Radio Shack of the "Jacob Ruppert." The signals from this transmitter have already become familiar under the call of KJTY. The radio room is only a few feet square and it is impossible to show a complete view because of the limited space. Brush crystal microphones are located not only in the radio room but in other places in the vessel, where the various parts of the programs originate.

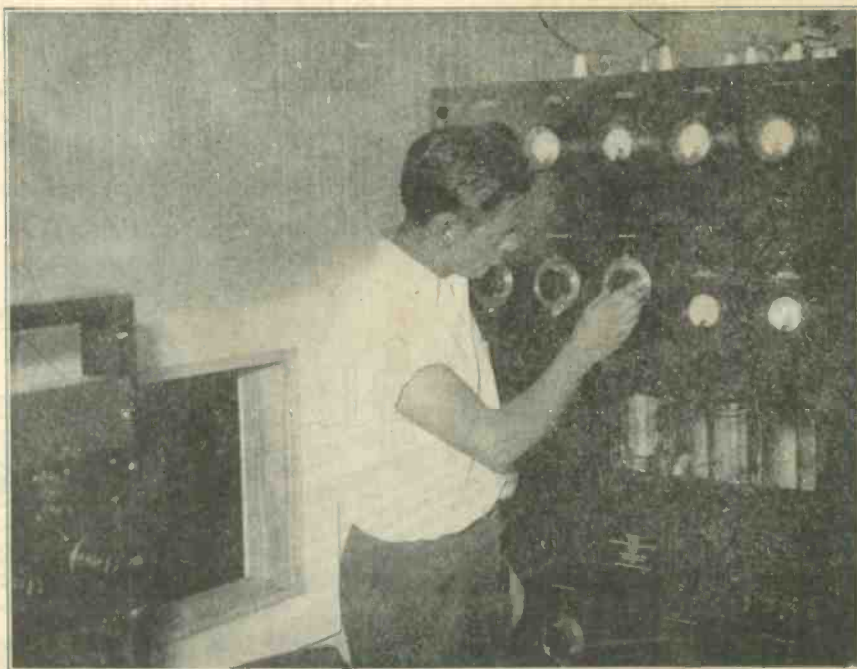

FEATURE ARTICLES By . . .

Clayton F. Bane	- - - -	Col. Clair Foster	- - - -	Norris Hawkins
I. A. Mitchell	- - - -	G. F. Lampkin	- - - -	Louis R. Huber

RADIOTELEPHONE DEPARTMENT . . HAM HINTS . . TUBE TECHNIQUE
 AMPLIFIER DATA AMATEUR NEWS "SCRATCHI!"



Magnavox

A name that protects yours!

A chain is only as strong as the weakest link!

IN RADIO, Speakers and Capacitors—component parts of every set—are important links. Quality performance of your product depends on them. Be sure they bear the name MAGNAVOX... a name that has stood for advanced engineering, quality and dependability since Radio began.

MAGNAVOX pioneered and weathered the storms of Radio's development era, yet Magnavox is still a "great name" in Radio. Twenty-four years of experience has produced an organization with sound and alert management, adequately financed, and with a reputation for building Speakers and Capacitors of merit.

FOR YOUR PROTECTION in quality, performance, price, engineering and delivery, choose Magnavox Speakers and Capacitors. For the sake of your own good name, you cannot afford any but the best in the sets you build.

Anticipate an announcement of unusual interest soon from
SPEAKER AND CAPACITOR HEADQUARTERS

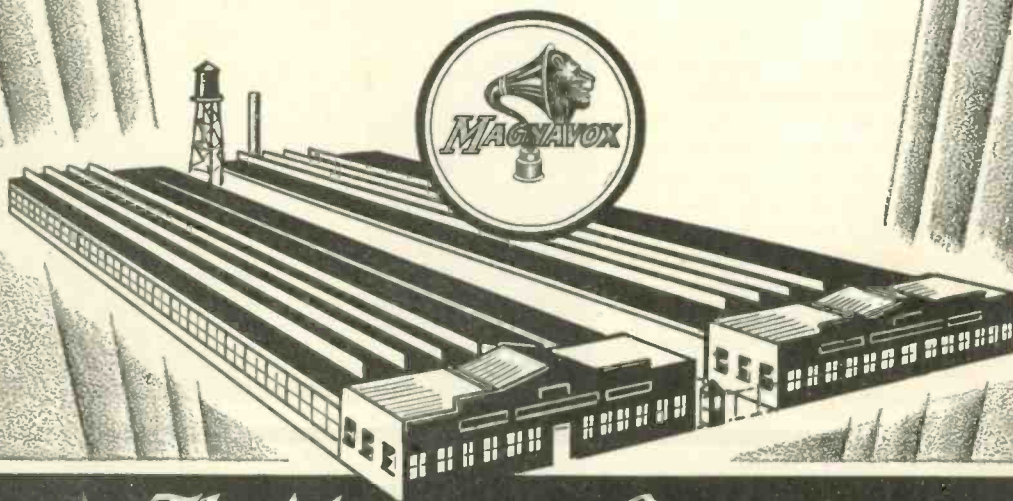

The Magnavox Company

FORT WAYNE, INDIANA

CABLE ADDRESS "MAGNAVOX" U.S.A.

BRANCH OFFICES:
 New York City,
 253 W. 128th St.
 Tel. MOument 2-2812
 Boston,
 J. H. Condon,
 6 Marlboro St.
 Chicago,
 C. W. Nelson,
 3618 North Bernard St.
 Los Angeles, Calif.
 1455 Glenville Drive.

RADIO

ESTABLISHED 1917

Reg. U. S. Pat. Off.

A NATIONAL MAGAZINE - PUBLISHED MONTHLY

Publication Offices—Pacific Building, San Francisco, California

Clayton F. Bane, Editor

H. W. Dickow, Business Manager.

Norris Hawkins, Associate Editor.

D. B. McGown, Technical Editor.

Frank C. Jones, Ultra-Short-Wave-Engineering Editor.

Clair Foster, Amateur Activity Editor.

A. I. Rivett, Engineering Draftsman.

25c per copy, \$3.00 per year by subscription in the U.S. \$4.00 elsewhere. Send subscriptions to the San Francisco office. Entered as second class matter at the Post Office at San Francisco, California, under the Act of March 3rd, 1879.

Vol. 16

APRIL, 1934

No. 4

RADIOTORIAL COMMENT

Big Noises From Little Towns

IT SEEMS strange that the loudest-mouthed person in a small community is either the constable or his wagon driver. Perhaps they must be heard in order to be noticed.

There is a town in California called Burlingame . . . a village of the elite. It is a town of antique collectors, some antique citizens, thousands of commuters who choose the peace and quiet of a country village to the midnight rackets of a big city and the usual run of just plain people.

Thus in this village a storm is brewing. For an ordinance has been passed, barring the amateur from the air with his radiotelephone equipment until after 11 p.m. It all came about because somebody in the village complained that the 160-meter fone signals were slopping all over a BCL radio receiver. An influential citizen probably went to the bat and had an ordinance passed.

A radio inspector made a quick investigation. He found that the interfering 160-meter fone amateur was duly licensed, had his shack in order, complied with all regulations and HAD SPENT MORE THAN TWO THOUSAND DOLLARS for the finest kind of 160-meter fone equipment. "He's within the law", said the radio inspector. "He's NOT!" says the constable. What's going to happen? . . . Uncle Sam says the man can operate his fone any time, all the time, and not only after 11 p.m. as the city council says he must do, according to the ordinance.

The radio inspector's badge of authority on one side, the constable's club on the other. Whatinell is a poor amateur going to do in a case like that?

That's not all. The Burlingame city council has made movements to get other neighboring towns to pass a similar ordinance.

Worst of all . . . upon investigation the radio inspector found that the complaining witness who was being treated to hamfoney instead of BCL free radio advertising, was found to have in operation a receiver of the vintage of the Year One when radio began. It is one of those nice pieces of furniture that used to sell for about a thousand dollars, but what's inside the cabinet is probably as antique as the mode of living of the person who filed the complaint against our brother ham.

Must an amateur with a \$2,000 fone investment give way to the antiquated radio receiver which brings in almost all stations at one time? Can there be no regulation passed which makes it prohibitive for a person to complain of modern amateur fone interference UNLESS he has a MODERN receiver?

Just because a person does not want to part with the got-stung radio set which cost so

much in years of old, is no reason why the amateur should be forced to shut down his modern transmitter.

Next of importance . . . if these 160 meter fones of the amateurs are giving the BCL's an added program which they didn't expect to get when they bought the set, and because so many people refuse to buy modern sets, preferring to wear out the original investment of an antiquated BCL set over a period of a lifetime, why do they put the amateurs 'way up there on 160 meters, right next door to the peanut broadcast stations?

Much interest in this case is evidenced along the Coast, because it is a new one on the amateur. Shortly we will learn whether Uncle Sam is right, or if the constable has the authority to keep a 160 meter fone amateur off the air until his antique neighbors move or die. Perhaps a better law could be passed . . . one that would make the BCL's go to bed at 8 p.m. and leave the amateurs alone.

The Beginner vs. The Newcomer

THE rapid growth of amateur radio has brought into the fold two distinct classes of people, beginners and newcomers. Too often the newcomer is called a beginner, whereas it is a fact that among the newcomers are many of the old-timers of the pioneer days in radio. Thus a distinction should be made between the two.

A few weeks ago our amateur station was visited by a man who had not listened to a radio signal in fourteen years. He was amazed to learn of the rapid progress which has been made by the amateur and he decided then and there to build a transmitter and receiver so that he could once more get back on the air. In those fourteen years which have elapsed he had not forgotten the code . . . can copy almost everything that comes over the air.

Before constructing his transmitter he asked for our candid opinion as to what he should build. We advised him to start right . . . with crystal control. It must be admitted that even a single-tube crystal control transmitter, properly adjusted and operated, will outperform the antiquated key-clicking and thumping self-excited outfits.

This "newcomer" is going to start right in amateur radio. He is not going to be just another key-clicker and thumper, like so many of the other class, the beginner who doesn't care. But let us not blame the beginner alone for the interference which he is creating with his inefficient and out-dated transmitter. He has been told for years that the self-excited transmitter with one or two 45 tubes is the right way to get started in amateur radio.

The experienced amateur has long since given up the one-tube self-excited transmitter with the big tank coil and the little tube. He has found a remedy for key clicks and thumps. He is considerate of his brother-amateurs. Those old-timers who cannot yet afford to buy a crystal and holder . . . those who must use a 45 transmitter, have found from experience how to properly operate and tune it.

But the inexperienced beginner . . . the fellow who believes everything he reads in a newspaper, is the one who has had the 45 self-excited click-thumper transmitter literally shoved down his throat. Every transmitter, no matter how small, is a potential source of clicks and thumps, unless precautions are taken to prevent them. The inexperienced newcomer regards as Gospel what is told him by the "powers that be". Therefore, the blame rests fairly and squarely on the shoulders of those who encourage more and bigger clicks and thumps. A poorly-adjusted 45 transmitter can cause more disturbance in a congested area than a pair of 852's running full blast.

So let us draw a distinct line between the two classes of people who are flocking into amateur radio. Let us call the old-timer, who is again coming back into the ranks, a NEWCOMER. And let us refer to the inexperienced army as BEGINNERS.

To both these groups we advocate crystal control, or some sort of stabilized oscillator driven M.O.P.A. The Dow Oscillator-Amplifier transmitter shown elsewhere in these pages is an ideal newcomer's or beginner's transmitter. It has a key-click filter and, if properly adjusted, will give splendid satisfaction. Before you go on the air, or if you are ready to make a change from your antiquated equipment, give consideration to this transmitter.

How many inexperienced beginners are complying with the D.C. regulations? How many of them are using that antiquated tuned-plate-detuned grid, self-excited relic which is so generously advocated in recent literature? "Too late", says the beginner . . . "I've already spent my last dime on a self-excited rig." But it is not too late. Those who have invested in a 45 tube and associated equipment can add the Dow Oscillator (Electron Coupling) to the initial job and improve its performance enormously.

If every newcomer and beginner would first consult his local radio club or make the acquaintance of several good amateurs in his community, it seems certain that the air will sound more like "PDC". All of us, newcomers, beginners and old-timers alike will get more out of amateur radio.

COL. FOSTER'S COMMENT

W6HM

Amateur Radio Is Not Forbidden in China

MUCH propaganda is being disseminated from the East in the effort to kill off every last vestige of service to our citizens in the Orient who benefit from the work of amateur stations. Most of this propaganda comes from sources purportedly amateur.

A case in point is a letter written recently to an amateur in San Francisco in which the writer attempts to prove that amateur stations in China are operating "illegally". The letter goes even so far as to declare, "As a result, amateur radio is absolutely forbidden in China by law." A more flagrantly untruthful statement could hardly be imagined!

The letter tells the San Francisco amateur such trash as this: "The Chinese Government regards the foreign concessions and the International Settlement in China as an insurmountable barrier to the encouragement of amateur radio because they cannot control the action of foreigners in those areas".

On the contrary, the highest officials of the Chinese Government—including President Chaing Kai Shek and Minister of Finance T. V. Soong—are availing themselves of the services of amateur stations located within the International Settlement of Shanghai and in all other parts of China; and amateurs have many letters of grateful appreciation from these officials.

This was confirmed specifically by Harold Graham, AC9GH, of Changsha, who visited me here in Carmel a few days ago. And what Graham told me confirms also what has been told me through the course of years by such responsible and well-informed amateurs as Hubert MacGowan, AC8HM, (second in command of the Dollar Steamship Company's passenger business in the Orient), by Cliff Dow, (old 6ZAC of Honolulu, NPU at Samoa, NPG at Mare Island, and later manager of the Chinese Government station at Shanghai), by Earle Chang, AC8GO, (formerly VE5GO and now operating a broadcasting station of his own in China), by Dr. William Malcolm, AC3MA, (Port Physician of Chefoo), and by many other men, both amateur and commercial.

Another sentence that sticks out like a sore thumb in this eastern letter to the San Francisco amateur is this: "Since the government of the United States recognizes the Chinese Government as its peer in international matters it is indeed difficult for us to get anywhere on behalf of stations that are purely outlaw and which would not be permitted to exist if the Chinese Government had enough strength to realize its wishes."

The International Settlement

THE writer of this letter to the San Francisco amateur besides displaying his utter ignorance of the radio situation in China assumes even to know the WISHES of the Chinese Government! In spite of the cool assertion of the writer, the Chinese Government has a large measure of control of the International Settlement of Shanghai. About the only functions of government not con-

trolled by the Chinese Government are those of the courts that try cases in which foreigners are involved. The administration of the International Settlement is largely in the hands of officials of the Chinese Government.

The Chinese Government wants no commercial stations other than their own within the Settlement. The French from time to time have operated a station in their section of Shanghai. This station is an irritant to the Chinese Government and its operation sooner or later must cease. Both of the large commercial stations managed for the Chinese Government respectively by Globe Wireless and RCA are outside the International Settlement, of course; but within the Settlement there are many amateur stations operated not only with the sanction of the Chinese Government but also with that government's approval.

Chinese Approve Amateur Traffic

IN FACT it is with the approval of the Chinese Government that the Shanghai Amateur Radio Society, (of which Commander Mathes and I were made the first honorary members) arranges the routing of amateur message traffic, prints and distributes widely a monthly bulletin naming the various traffic schedules and the number of messages handled by amateur stations, and publishes all new amateur station calls. It was this amateur society that partitioned China into the nine zones observed by amateur stations. That is why we hear amateur calls running from AC1 to AC9; and that is why we have seen these calls published for years in the Call Book that circulates internationally throughout the world.

And that is why the following quotation from the propaganda in question is so subversive of the truth: "I am positive there is nothing we can do in the case of the fellows like AC2RT who are on purely Chinese soil; I am still casting about for means of accomplishing something in the case of those who are in the International Settlement of Shanghai, but to date I cannot establish anything other than that they are similarly pirates, taking advantage of extra-territoriality and the difficulty which this makes for the Chinese in enforcing their regulations except by formal international complaint in each individual case."

And this propagandist has the consummate cheek to call "pirates" these fine amateurs who have the grateful approval of the highest officials of the Chinese Government! If this man has ever seen these "Chinese regulations" of which he speaks with all the finality of an oracle he would better print them in his magazine for the enlightenment of those of us who know a thousand times more about radio conditions—both amateur and commercial—in China than he himself will EVER know.

And he is "still casting about for means of accomplishing something" for the Shanghai amateurs; And this from the man who has tried for years to stop these stations from

handling third-party messages—the very activity that has won the acclaim of the Chinese Government itself! Did anybody ever before hear such blatant hypocrisy!

Who Pays For the Propaganda?

IT COSTS money to write, print and distribute such propaganda. In this case the expense is not borne by the propagandist; it comes out of the pockets of the very men the propaganda is aimed at. Funds provided by amateurs themselves are available for the use of this propagandist in carrying out his own purposes. The money is all at his disposal. All he has to do is reach for it. When he wishes to print a pamphlet, or an article in his magazine, or send out letters such as this, the money is right at his hand and he may use it without let or hindrance for such purposes.

And it costs money to refute propaganda; but the expense of the refutation must come out of the pockets of the individual men who in the interest of ALL amateurs are doing the refuting.

Even the men who are used as the tools for the dissemination of false propaganda are working for the propagandist at their own expense. The propagandist makes use of innocent men like the San Francisco chap to spread HIS stuff at THEIR expense. This propagandist capitalizes for his own purposes the energies and enthusiasms of sincere but uninformed amateurs who will soak up his doctrines and then run around and spread them among his acquaintances—doctrines that have no purpose but to weaken the position of the amateurs themselves.

Aw, wake up, fellows, and stop being so gullible!

Clair Foster, W6HM.

What Judge Sykes Says About the Treaty

THERE has just come to hand a revealing letter that was written to an amateur on December 22, 1933, by Judge Eugene Sykes himself. After quoting the amateur regulations of the International Radiotelegraph Treaty of 1927 and those of Madrid in 1932 he has this to say:

"The essential difference that may be seen by a comparison of the two articles is that under the Washington agreement international third-party traffic was permitted with all countries unless one of the countries concerned had notified its objection thereto, whereas, under the Madrid convention this exchange is only permitted between two countries who have notified their agreement thereto.

"In order to protect the amateur as much as possible under the new agreement, and to consummate verbal assurances which were given to amateur representatives at the time they agreed to the compromise at Madrid, steps are being taken by the Department of State to negotiate agreements along the lines indicated above with a number of foreign na-

(Continued on page 32)

SLIDE

By LOUIS R. HUBER*



When not mining copper or pounding brass, the operator of K7BLLI was an enthusiastic disciple of Isaak Walton. Al Domenico is shown here holding a prize catch. The six-shooter and the string of .45's shows he was loaded for b'ar.

THE camp was not in an easy frame of mind when Al Domenico laid down his headphones and turned to his bunk after three steady hours of waggling his key.

"Bridge out at Chitina. All wires down and amateur radio only communication until repairs made."

The message had sung through the air by short-wave radio from the bleak mountainside at Kennecott, had rattled the headphones of K7FF at Chomly and was passed on to W7TX in Seattle, who immediately put it on the Western Union to New York City.

The message had gone on to say: "... warm spell struck us

yesterday. Men removed from Camp Erie account imminence of slide. Will wire later."

But Al took it all philosophically. "A Chinook wind in the middle of February in Alaska", he muttered to himself as he drew the covers up to his chin, "bodes ill for



Jumbo Camp, the scene of the disaster which wiped out half the buildings of the mine, killing several men and injuring many more. The barricade, or "snow divider" at the extreme right was supposed to sidetrack avalanches but in this case the snow poured right over the barricade. K7BLLI was located in the long building at the right.

all men. Let us take heed for the future and ...

He was interrupted by clattering echoes down the hall. A door slammed and hard heels pounded along the board floor.

"And let us pray", continued Al, "for the manufacture of rubber-heeled shoes, their enforced use in all bunkhouses, with a penalty for the violation of this provision. Amen!"

He turned on his side, buried one ear in his pillow, and snored experimentally, ignoring the pounding heels. The staccato rap of leather on wood continued, approached right up to the door; a hand jolted the door knob, and Al flung himself around to see his room mate, the pump tender, waving in search of the chain-pull on the ceiling light.

"I guess I don't sleep until after the rubber industry merges with the shoelather. . ."

"Here's a message," said the pump tender, ignoring Al's remonstrance, "here's a message the boss sent me up with. Says to put it on

the air right away with that contraption of yours. Better read that quick, old man!"

He turned and left, hard heels clattering down the hallway and disappearing with the slam of a door. Al sat up and yawned.

"And to think that my abominable radio transmitter interfered last evening", he ruminated, "with said foreman's reception of Amos 'n' Andy. It ought to be legislated off the air, honest. . . Well—K7FF is in bed now,



K7BLLI, a familiar call to radio amateurs of the Pacific rim, was wiped out in the great slide of 1932. Only the receiver (not shown here), a B battery and the operator's bug key were salvaged. Strangely enough, they were enough to keep the mine in communication with the outside world.

but W7TX probably is on. I think he never goes to bed."

The probability of transmission thus established, Al unfolded the message, and what he saw opened his eyes, wakened him back to the freshness of hours ago.

"... small slide killed Antone Jensen at Jumbo six ten o'clock today. Moving all men to Bonanza tonight if weather unchanged."

Al would have uttered appropriate exclamations at this point, but for the strange groaning, rattling sound which hummed through the whole building, grew alarmingly close and then fetched up about his ears with a deafening roar and a chaos of motion. The floor and the end of the room seemed to move at him in one great lunge, then to fold in and out, clapping and squeezing him on the arms. He heard the faint ring of breaking glass beside his ear, and realized that amid this huge cacophony of noises he had fallen—or the bench that held his transmitter at the end of the room had risen and hit him—so that his prize '52 tube had collided with his ear.

A moment later he was aware that his arm hurt and that snow was running down his neck. When he looked about him there were no walls: only a heap of boards and snow, and directly in front of him was a heavy-duty "B" battery. An end of the ridge-pole to the bunkhouse stuck up on the snowpile behind him and waved crazily in the breeze. Someone groaned below him. He heard voices up the hill, someone shouting about picks and shovels and saying "It's all down now—that there mountainside's as clean as a hound's tooth!"

Kennecott, Alaska, as any reader of the stock-market pages can tell you, means copper. It has poured millions of dollars into the coffers of the Guggenheims, has built a steamship line and a special railroad to carry shining bars of copper to a world waiting for wire and Indian-headed pennies.

But Kennecott, Alaska, also means a handful of buildings clustered beneath the sharp-pointed peaks of the high coastal range in central Alaska, from whence a little, spidery

line of cables slims still higher and crosses over perpendicular walls, finally to descend to another cluster of buildings hung on the remote side of saw-toothed church-like spires. This is Jumbo, number-one camp of the Kennecott copper mines. From Jumbo, tunnels run through the solid rock of the mountainside to Erie and Bonanza, number-two and number-three camps.

This sort of territory is majestic—and terrible. It is majestic in the sense that God probably never assembled steeper mountains and clothed them so beautifully in snow. It is terrible in the sense that He made them largely of copper and so induced a money-mad world to send men up there to claw at the mountain peaks with steel cables and invite the beautiful snow to give way and slide down as it did during this fine, warm February morning, wiping a bunkhouse neatly from the insecure footing of forty-five degrees, killing several men and injuring many more.

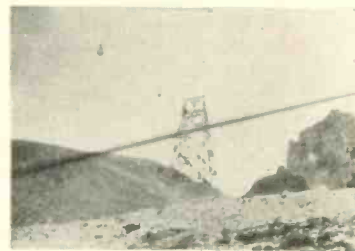

The favorite mode of travel around the Kennecott district is by bucket-and-cable. Four miles of this kind of transportation connect Kennecott proper with the three mines, Jumbo, Erie and Bonanza.

It is terrible, too, in the sense that a money-crazed management believed a few threads of paltry copper were enough communication for one of the world's largest copper mines.

"We're not going in for any of this expensive wireless stuff," they said.

It would have been even more terrible if Al Domenico and J. McGavock, hard-rock



Kennecott—the main camp of Alaska's largest copper mine. Kennecott, in the interior of Alaska, is connected with the sea-coast by a railroad built solely to convey the copper to a steamship line founded primarily for its transportation. Note railroad cars toward upper right. The low white building in the center is one of the best-equipped hospitals in Alaska.

miners working on wages at the mines, had not taken a side-interest in that "expensive wireless stuff" and installed amateur stations of their own, for their own amusement. But they did and, while McGavock was not so strong on operating, Al Domenico took to radio as a duck takes to water and his call—K7BLLI—was heard far and wide almost nightly after he finished his trick at the pumps at the head of the mine shaft.

(Continued on page 29)

* W9SU-K7AHK-W7CRJ, 517 East Fourth Street, Tipton, Iowa.

The A to Z of Link Coupling

—and How to Get 25% More Power Output

By The Technical Staff Of "RADIO"

Advantages of Link Coupling Over Other Types

- (1) Automatically establishes correct impedance relations between grid and plate circuits.
- (2) Permits most efficient operation of circuits wherein low- μ tubes work into, or out of high- μ tubes, and vice-versa.
- (3) Provides a flexible feed line, which may be several feet in length, and which results in efficient operation between stages in "rack type" transmitters in which the stages are spaced quite far apart.
- (4) Permits the use of series-feed in both grid and plate circuits, entirely eliminating the use of RF chokes.
- (5) Makes possible maximum power output and attendant lack of "crankiness" when high- or low-frequency crystals are used.
- (6) For a given amount of excitation on the grid of the first buffer, the use of link coupling reduces plate current in the crystal oscillator stage and therefore reduced the RF current through the crystal itself.
- (7) Eliminates the use of taps on coils, with their attendant losses.
- (8) Because of the lack of capacitive coupling effect, neutralization is made easier.

THE question often arises in radio circles as to the advantages or disadvantages of a particular form of coupling. The types of coupling that are in most general use are "Capacitive" and "Inductive." The latter includes the popular "feed-line" systems. In order to form an opinion as to the type which will prove most suitable for a particular transmitter it is almost necessary that the underlying principles are clearly understood. It is therefore the purpose of this article to present such information.

Radio frequency energy is usually transferred from stage to stage in a transmitter for the purpose of frequency multiplication or amplification. Since the output of the oscillator stage is usually of a low order, it is generally necessary to build-up this energy by means of amplifiers until it is of such magnitude as to properly excite the final amplifier.

When energy is transferred from one stage to another, certain fundamental rules must be observed, else losses are inevitable. It is necessary, of course, that all stages get proper excitation if best results are to be obtained. This means simply that RF losses due to chokes and incorrect impedance matching must be avoided.

Energy is usually transferred from one stage to another by means of Capacitive, Inductive or Direct Coupling. Direct Coupling, though it has as one of its advantages the complete elimination of RF chokes, is so "tricky" as to be hardly worthy of further consideration.

Capacitive Coupling is accomplished by placing a single line between the plate tank of one stage and the grid of the next. Since the plate voltage must be kept off the grid, a small condenser is used in series with this lead. With this system we can have series-

feed and a consequent elimination of an RF choke in either the plate circuit of one stage or the grid circuit of the next. We cannot have both circuits series-feed. In the case of series-grid-feed, the coupling is shorted out and another is placed in series with the plate lead to the tank. The bias voltage can then be fed through the tank at the cold end (that end maintained at ground potential by the by-pass condenser), but we must feed the plate voltage directly to the plate by means of an RF choke. In the case of the familiar circuit shown in Fig. 1, the grid is shunt-fed, i.e., an RF choke to allow the DC voltage to get to the grid, and at the same time offering a high impedance to the RF voltage to the grid.

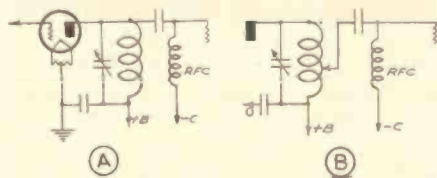

FIG. 1

FIG. 1 (A)—Fundamental Capacitive Coupled Circuit. "C" is the capacity-coupling condenser. Aside from the impedance mismatch which results from use of this circuit, the RF choke (RFC) is practically always a source of loss. Thus the circuit possesses two evils, which are eliminated when link coupling is used.

FIG. 1 (B)—A capacitive coupled circuit with the plate coil tapped a few turns down from the plate end. That portion of the plate coil below the point where the tap is taken, acts also as part of an untuned grid in a TNT oscillator, which makes the driven stage oscillate at some parasitic frequency higher than that to which the circuits were meant to be tuned. The parasitic circuit includes the lower portion of the tank coil, the capacitive coupling condenser, the lead to the grid, the by-pass condenser in the negative B circuit and the ground.

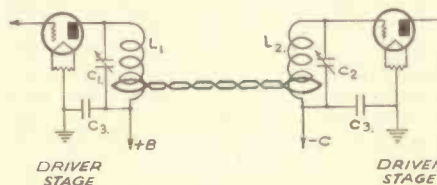

FIG. 2

FIG. 2—LINK COUPLING between the driver stage and the driven stage. Although no neutralizing condenser is shown, any of the conventional neutralizing systems can be used. The condensers C1 and C2 which respectively tune the plate coil of the driver stage and the grid coil of the driven stage are both of the same capacity, 50 to 100 mmf. C3 are radio frequency by-pass condensers, their sizes depending upon the frequency used. The higher the frequency the smaller these condensers can be. Usual sizes are .006 mfd. for 160 meters, .005 mfd. for 80 and 40 meters and .001 or smaller for 20 meters. The plate coil of the driver stage (L1) and the grid coil of the driven stage (L2) are identical in size and in number of turns used. Condensers C1 and C2 respectively tune these coils to resonance.

In order to get the maximum transfer of energy from one stage to another it is necessary for the grid impedance of the driven tube be equal to the plate impedance of the driver stage. This match is very seldom obtained with Capacitive Coupling because conditions under which tubes operate vary widely in practice. Theoretically, this mismatch of impedances can be avoided by the expedient of tapping down on the plate tank to obtain the correct match. The "auto-transformer" effect obtained by this method allows a vari-

able adjustment of impedance, either step-up or step-down, depending upon which impedance is higher. This tapping method has the disadvantage of encouraging parasitics, or self-oscillation.

Up to the present time it might have been safely said that the best RF choke is no choke at all. This however is no longer true, due to the recent advance in RF choke design. The new Hammarlund Heavy Duty transmitting choke is an example in point. Generally speaking, it is still good practice to avoid the use of RF chokes in all of the driver stages. Certain amplifier circuits which show a stubbornness against complete neutralization can be shunt-fed and one of these new chokes used to avoid the loss of energy sometimes experienced with older type chokes.

Inductive Coupling consists of transferring energy from the plate circuit of one tube to the grid circuit of another by means of mutual inductance which exists between any two coils whose magnetic fields interlock. The magnetic lines of force produced by one coil are intercepted or "cut" by the turns of the other coil, and a consequent voltage induced in this latter coil. This type of coupling is very commonly used in receiver design and one of its principal advantages is that it allows series-feed for the DC potentials which are applied to the plate of the driver tube and the grid of the driven tube.

By way of explanation, the bottom end of both coils are effectively at ground potential through the by-pass condenser to ground. Pure Inductive Coupling, where the grid coil is placed directly alongside the plate coil, has certain disadvantages. The tuning adjustments are very cranky because in order to get enough coupling between the two windings for maximum energy transfer, the grid tuning detunes the plate tuning and it is almost impossible to get both of them right on the peak. Another drawback to straight Inductive Coupling is that which develops when two coils carrying high RF voltage are placed in close proximity to each other. Capacitive Coupling, as well as Pure Inductive Coupling is then introduced, making neutralizing difficult, if not impossible, as well as preventing the use of extremely low-C, which is so desirable in crystal control transmitters.

These difficulties encountered when straight inductive coupling is used are entirely obviated in a special form of inductive coupling generally termed "Link Coupling". A modified form of the present system of link coupling, and which uses a twisted pair feed line, was presented simultaneously by several writers. With pardonable pride the staff of "RADIO" has largely been instrumental in the present-day widespread use of this system.

LINK Coupling provides a low impedance transmission line to transfer energy between two isolated tank coils, one of which is the plate tank of the driver stage and the other the grid tank of the driven stage. This low impedance transmission line provides coupling of purely inductive nature, the capacitive loading effect of the single turn loop being negligible. In this way the capacity between the tank coil and the coupling

loop is not shunted across the tank tuning condenser, which would considerably reduce the L-to-C ratio.

Some are of the opinion that link coupling represents an unnecessary complication and is critical in operation and complicated in its construction. Nothing could be further from the truth. It automatically provides a proper impedance transformation without undue attention on the part of the operator.

The position of the coupling loops on the tanks in the low power stages is generally non-critical. By this we mean that if the coupling loop on either tank is placed in the approximate center of both coils, good results will be obtained. When working into or out of high- μ tubes, the position of the coupling loop demands more careful attention. Generally speaking, it will be found that the coupling loop on the plate tank of the high- μ tube will have to be placed relatively close to the cold end of the coil. This is the case when using a 47 as a crystal oscillator.

When coupling into the grid circuit of screen-grid tubes, such as the 865, it is sometimes good practice to place the coupling loop closer to the hot end. Screen grid tubes sometimes have a tendency to oscillate under certain conditions of grid impedance.

Whereas the placement of the coupling loop near the hot end of the coil is not necessarily the most efficient point from the standpoint of output, the impedance change is often largely instrumental in reducing the tendency to oscillate.

Feed lines, consisting of twisted pairs, can be several feet in length. Lines of this length heat-up appreciably when used in high power transmitters. With low power, no hesitancy need be felt in the use of a long feed line.

The feed line wires can be ordinary rubber covered lamp cord, although the use of a solid conductor with good insulation is recommended.

A reference to the illustrations shows some of the various mechanical arrangements suitable for this type of coupling. In the low power stages, it is recommended that one of the fixed-coupling-loop systems be used. We have shown vertical plug-in coils, wound on the usual Isolantite coil forms, because this type of coil form is ideally suited for the fixed coupling loop. Other systems, some of which are also shown in the sketches, have one coupling loop adjustable from the base-board. Since this latter system requires the use of two parallel rods several inches long, these rods act as a continuation of the feed line. In conjunction with this system, where the twisted pair feed line is connected to the ends of the rods, an extremely important point arises. The feed line has a very definite polarity and sometimes, unless the feed line leads are reversed, it is impossible to obtain anything like a normal transfer of energy.

Single Or Double Loop?

THOSE who contemplate using the double loop feed line system for the first time will be confronted with the question as to whether or not these small single turn loops can supply sufficient coupling. We have never experienced the slightest difficulty in running the plate current of the driver stage to abnormal limits in any of our transmitters. In fact, it has always been necessary to move the loop back toward the cold end of the coil in order to maintain the plate current at a normal operating value.

Many have asked for a comparison between the relative merits of the double loop and the single loop tap-on systems. Properly adjusted, these two systems are identical. From the standpoint of simplicity of mechanical construction and ease of electrical adjustment, we much prefer the double loop system.

Some recent articles in contemporary publications have shown "our" single turn link

coupling system but with the use of multi-turn coil. This is entirely unjustified, in our opinion. The only point to remember when the single turn system is used is not to make the coupling loop more than $\frac{1}{4}$ inch all-around diameter larger than the diameter of the coil over which the coupling loop is placed.

We were greatly surprised to find that many amateurs had forgotten to include the by-pass condenser from the cold end of the grid coil to ground. Without this condenser the node is no longer at the bottom of the coil, but establishes itself in the electrical center. With the bottom end of the coil "hot", the use of series-feed is completely nullified and demands the use of a good radio frequency choke. Without discussing other evils caused by leaving out this condenser, let us merely state that its use is absolutely necessary.

(Continued on page 30)

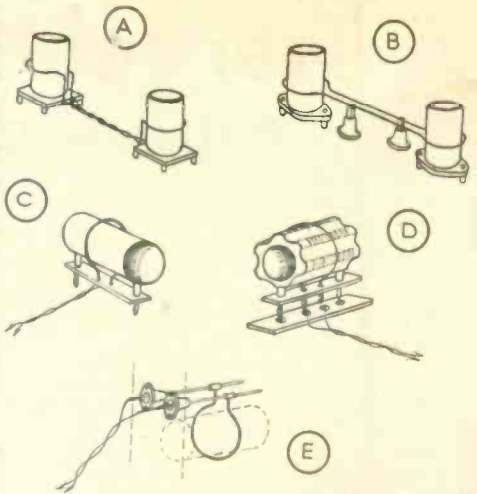

Mechanical Arrangements For Supporting Link Coupling Loops and Twisted Pairs

(A)—Two Hammarlund Isolantite coil forms in a link coupled arrangement, one coil for the plate, one for the grid. The coupling loop, which is $\frac{1}{4}$ -in. larger in diameter than the outside diameter of the coil winding, is made from a piece of No. 14 rubber covered wire. The loops are held in position by merely soldering the respective ends to the contacts on the sockets into which the coils are plugged. Then a twisted pair, or "transposed feed line" connects the two loops together into a continuous circuit as shown in illustration (A). In (B) the same coil forms are used, but the coupling loops are held in position by two standoff insulators having $\frac{1}{2}$ -in. collars, which raise the loops high enough so that they encircle the coils at almost the center of the form. Best results are secured when these loops are below center of the coil, i.e., closer to the "cold" end. When the plate and grid coils are only about five inches apart, the feed line in low-power stages need not be transposed, as shown in (B). Illustration (C) shows a home-made coil form with supporting collars at each end. The coupling loop is held in position by drilling two holes through the coil supporting base and the twisted pair soldered to the ends of the loop.

(D) shows the new General Radio 2 1/2-in. ribbed low-loss transmitting coil form for higher-power stages, such as an O3-A, or other 100-watt tubes, either singly, in push-pull or in parallel. The General Radio coil form can be supplied with a low-loss mounting base, as shown in the illustration. On this base are a sufficient number of jacks so that the link coupling loop need not be plugged into two of the jacks which are provided. This arrangement makes a professional-looking and performing job.

(E) shows a method for supporting two rods on which a link coupling loop, fitted with sliders, can be moved from one end of the coil to the other, so that the coupling can be varied. Two stand-off insulators hold the slider rods in proper position. It is sometimes advisable to reverse the connections of the feed line to the loop when using this method, particularly when metal slider rods are used.

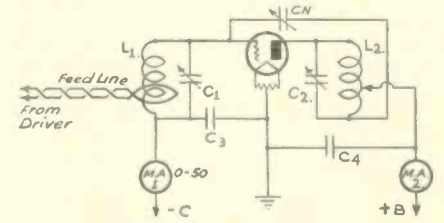
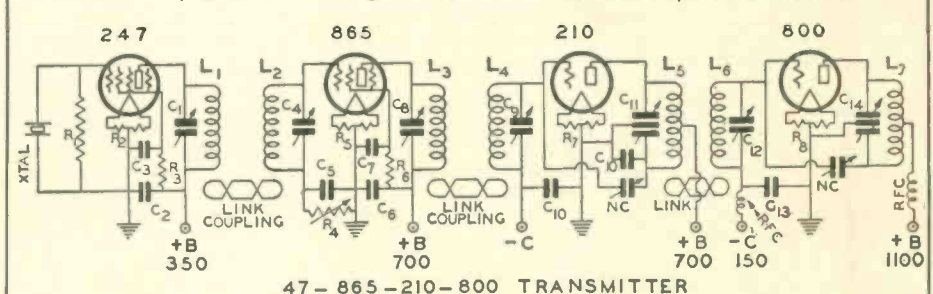

FIG. 3

Fig. 3—How To Adjust a Link Coupled Transmitter Stage

TUNE C2 to a point that is known to be off resonance. Place the coupling loop around the center of the plate tank of the driver stage. Place the other loop at the center or toward the cold end of the grid coil L1. Note the reading as indicated by MA1. This operation should be made with the plate voltage disconnected, but with the center-tap of the tube connected to ground (or minus B). Then tune C1 for maximum reading as indicated by MA1. Tune C2 to a point where MA1 takes a decided dip. Set and leave C2 at the point where MA1 shows the lowest reading. With the tap set in the approximate position for correct neutralization on L2, adjust neutralizing condenser NC for the maximum reading on MA1. For each setting of the neutralizing condenser C1 must be reset to bring the grid current back to maximum. The highest reading of grid current during this compensating adjustment is the point of correct neutralization. When C2 is tuned through resonance no change in grid current should be indicated by MA1. If this meter shows the slightest flicker, the stage is not neutralized and the adjustment must be repeated, but with a different setting for the tap on L2. The correct position for this tap must be determined by experiment. For tubes of the 210 type, and when using a neutralizing condenser of approximately 50 mmf., and if a 12 turn coil is used at L2, the neutralizing tap should be placed at about 4 turns from the neutralizing (bottom) end of the coil. In this circuit the by-pass condenser from high voltage to ground is essential for complete neutralization. When all adjustments have been satisfactorily made, apply the plate voltage and adjust C2 until MA2 indicates minimum current.

Complete Circuit Diagram of a Modern Link Coupled Transmitter



47-865-210-800 TRANSMITTER

List of Parts Required for Modern Link-Coupled Transformer

- | | |
|---|--|
| C1—50-100 mmf. | C14—Split stator V.C., 50 mmf. per section. |
| C2, C3—.002 to .006 mfd. | NC—Neutralizing Condensers. |
| C4—50-100 mmf. | R1—10,000 to 50,000 ohms. |
| C5—.006 mfd. | R2, R5, R7, R8—100 ohm Electrad Center-Tap Resistors. |
| C6, C7—.002 to .006 mfd. | R3—35,000 ohms, 5 to 10 watts. |
| C8—100 mmf. | R4—0-25,000 ohm, Variable Resistor. |
| C9—100 mmf. | R6—50,000 ohm, 10 Watt Resistor. |
| C10—.006 mfd. | L1 and L2 are same size; L3 and L4 are same size; L5 and L6 are same size. See coil table. |
| C11—Split stator V.C., 50 mmf. per section. | |
| C12—100 mmf. | |
| C13—.006 mfd. | |

A Transmitter for the Newcomer

It Uses the Dow Oscillator and a '45 Amplifier

IT IS astounding to learn of the large number of beginner-amateurs who are using 45 tubes for transmitting. Obviously these tubes are used essentially because they cost so little. Persistent efforts on our part have utterly failed to convince the beginner that there are other tubes which will do the job in a more efficient manner. Although we can offer technical advice, we can hardly dictate how much a man should pay for his tubes. The problem then resolves itself into one of providing a transmitter incorporating one or more '45's, designed so that these tubes will operate at their maximum efficiency.

Most of the 45 type tubes are used in a tuned-plate-untuned-grid circuit for reasons which we cannot understand. The addition of a simple midget variable receiving condenser across the untuned grid coil will unquestionably result in much better performance. Wonders can be accomplished in improving the note in the output by proper adjustment of this grid tuning condenser. The fact still remains that even with this refinement we still have a self-excited circuit with all of its attendant inherent faults.

High-C in the plate tank circuit undoubtedly results in better stability but takes a great toll in limiting power output, and since there is not very much power to start with, this condition is certainly not very desirable. Swinging antennas and jumpy operating tables play their part in making the frequency more unstable. In our opinion, even the beginner's transmitter should be some sort of M-O-P-A, i.e., an oscillator with low power input and operating under conditions conducive to excellent frequency stability, working into an amplifier tube which has no bearing on the frequency. Since this amplifier has as its only function the amplification of the voltage supplied by the constant-frequency oscillator, it may be operated under conditions which provide maximum output from the particular tube in use.

In the selection of the type of oscillator, crystal-control is greatly to be preferred over self-control types. Heretofore the cost of the crystal and holder has discouraged many a beginner who would otherwise use it. This is hardly the case at the present time because a good crystal and holder costs no more in the long run.

If the cost of crystal control makes its use impracticable the beginner still has another alternative in the Dow Oscillator circuit. This circuit is the original electron-coupled oscillator, invented and popularized by Lieut. J. B. Dow, U.S.N., a number of years ago. This circuit, when properly designed, has excellent frequency characteristics. It has but one disadvantage—the frequency is not permanent, but can be varied at will. This flexibility is of disadvantage in the sense that the oscillator must always be carefully checked for frequency in order to prevent out-of-band operation. Use a crystal controlled transmitter if possible; the Dow Oscillator is a worthy substitute.

The voltages required for either a crystal or electron-coupled oscillator are low enough to enable the use of any of the common BCL power supplies or eliminators, if they have fairly good regulation. The amplifier can also be operated from the same power supply, but because it is usually advisable to use higher voltages on the amplifier than on the oscillator, another and larger power supply is more desirable. Again, one power supply can be made to suffice by using a larger one

in the first place, and by then dropping the voltage to the oscillator circuit by means of a series resistor. It would be better to use either one of the first two mentioned systems because the series dropping resistor has certain disadvantages, principally in that the voltage drop in the series resistor is not constant but varies with changes in plate current.

In the transmitter which we have designed, a 2A5 has been selected for the oscillator in preference to the 59 because the 59 tubes apparently vary quite widely in characteristics, depending upon the make. The 2A5 is a more sturdy and dependable tube and leaves little to be desired in its function as an electron oscillator.

The cathode tap on the oscillator coil is

The wires with the "fancy bends", as shown in the photographs, do not carry RF because they are merely filament and plate current leads. Mechanical vibration is something that one must fight shy of if a wobbly note is to be avoided. This little transmitter gives a beautiful, clear and stable DC note and the stability is really comparable to that of a crystal. All this can be nullified if the parts are not mounted securely and if the leads are not short and direct.

The by-pass condensers, five in number, are all of the older postage-stamp mica variety. These were used because they can be secured in most second-hand stores at a very reasonable price. They have mica dielectric and are capable of withstanding up to and including 500 volts without fear of breakdown.

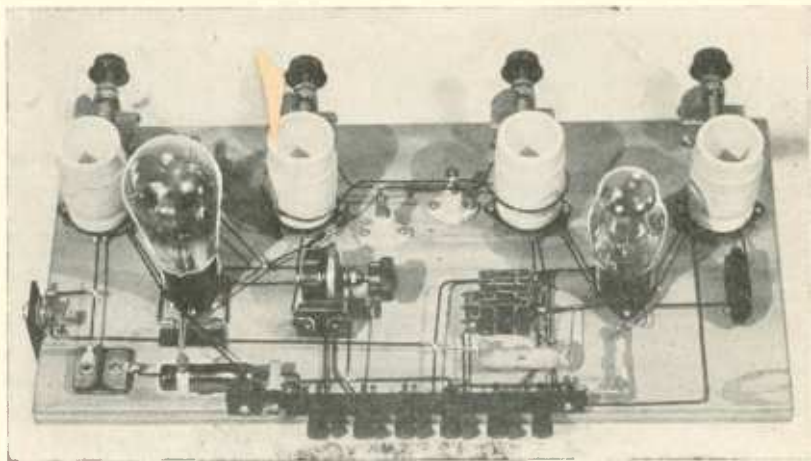

Breadboard construction simplifies the job. Note the Link Coupling between the two coils in the center. Because these coils are spaced but 5 inches apart, the feed line is transposed only at each end.

placed 10 turns from the ground end of the coil, the coil having a total of 30 turns of No. 22 DCC wire, close wound.

In building this transmitter extreme care should be taken to follow exactly the arrangement of parts as shown in the photo. The baseboard is 17 inches long and 8 inches wide, 5 ply veneer wood. From center to center, all coils are spaced five inches apart. This spacing is ample to prevent interaction between stages. Adhere rigidly to this spacing. The coil forms are standard Hammarlund Isolantite, 5 prongs, and plug into wafer sockets which are raised from the sub-base by 1/2-inch collars. Particular attention is called to the fixed coupling loop for the link coupling system used. The adjustment of the circuit has been greatly simplified by the use of fixed feed line and coupling loops, held in the proper position around the two coils by 1-in. standoffs which have a 1/2-in. metal collar extension to which the feed line is secured, giving a total height from the base of 1 3/4-in. The plate connection on the oscillator plate coil is made at the bottom of the winding, or, in other words, that part of the winding closest to the baseboard. This is apart from usual practice but was done in order to avoid not only long leads but also to keep the feed line of the link coupling system within reasonable limits.

Since this transmitter is not crystal controlled, it is absolutely necessary that all leads be made of heavy wire (No. 14 enameled) and also be as short and direct as possible.

The tuning condensers are Hammarlund Star midgets, selected because of their rigidity of construction, to say nothing of their low cost.

No external battery bias is used anywhere on this transmitter. Grid leak bias in the form of a variable resistance is used on the final amplifier. This variable resistance is necessary in order to get the correct adjustment and the most output for the amplifier stage. The particular resistance used happened to be of the carbon compression type, although other resistors will serve equally well.

Attention should be called to the resistance in the filament center-tap circuit of the amplifier stage. When the key is up the plate current of the amplifier tube causes a voltage drop across this resistance, and this voltage is impressed upon the grid, thus serving to reduce the plate current to a very low value. When the key is depressed this resistance is shorted out and the tube assumes its normal operating plate current. This system of keying is extremely beneficial in the elimination of key clicks and has one great advantage in that it is very simple and easy to adjust. Its only disadvantage is that when the key is up the tube still draws two or three milliamperes instead of zero plate current. This small plate current is additive to the normal backwave, making the total backwave on the air slightly greater than usual, although in no way impairing the readability of the signal.

The condenser connected across the cathode

resistor is absolutely essential for the complete elimination of the click caused by sparking of the key.

Tuning the Transmitter

FIRST apply voltage to the oscillator. Then, with the aid of a monitor, receiver or Neon tube, determine if the oscillator is oscillating. Assuming this to be the case, set C1 to the desired frequency in the band. Place a Neon lamp or flashlight bulb with loop on the plate end of L2 and tune C2 for

of C2 may give a still lower reading on the plate meter. With the key up, adjust R3 so that the plate current is the lowest possible value. The antenna can be coupled to the amplifier plate coil by any of the usual methods. A small piece of bakelite tubing, whose inside diameter is exactly the same as the outside diameter of the plate coil, can fit over this plate coil at the hot end and used as a variable coupling system for the antenna. The number of turns on this coil will depend upon the kind of antenna used. Try from 10 to 15 turns.

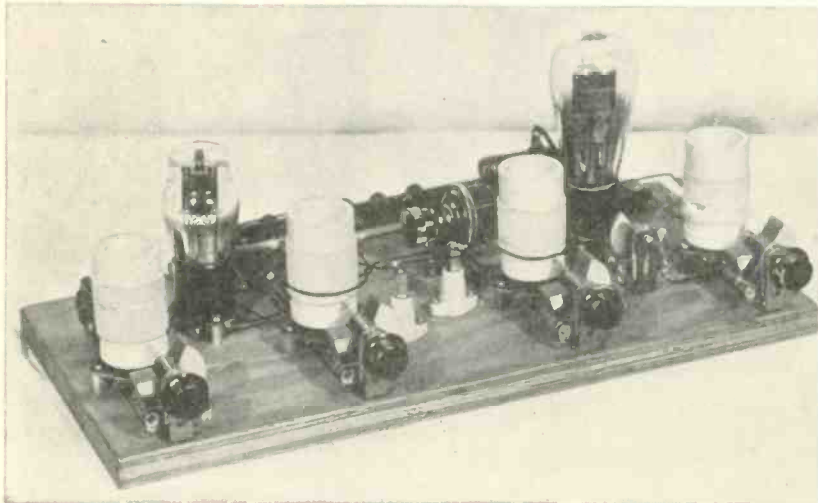

Front view of the transmitter showing symmetrical arrangement of parts

maximum indication. Now place the tuning indicator on the grid side of L3 and tune C3 for maximum resonance. Close the key, shorting out R3, and adjust R2 to some intermediate point. With the plate voltage disconnected, place the Neon tube on the plate end of L4 and tune C4 for maximum indication. Meanwhile readjust C3. The neutralizing tap on L4 should be placed in the correct position as shown in the diagram (20 turns from the bottom of the 245 plate coil). With the Neon indicator still on the plate end of L4, tune CN until there is a total absence of glow in the Neon lamp at some setting of the neutralizing condenser. Open the key and apply the plate voltage to the amplifier. It is well to put a closed-circuit jack in the B-plus lead to the amplifier so that a milliammeter may be inserted at this point for accurate tuning. Close the key and adjust C3 and C4 for minimum reading on this plate milliammeter. A slight readjustment

Summary

EITHER the type of keying shown, or keying in the primary of the high voltage transformer should prove entirely satisfactory for the elimination of key clicks. Move the family BCL set as close to the transmitter as the old man will allow, and check-up on the key click situation for yourself.

Remember, any transmitter—no matter how simple or how elaborate, will in all probability have key clicks unless some means is taken to prevent them. When you decide to go on the air with your first transmitter give a little thought to the other fellow and you will be surprised to find that your number of station contacts will soon assume large proportions. Selfishness does not make a QSO.

It is sincerely hoped that our small effort will serve to release the TNT Clickers from the fate which has befallen them, simply because they knew not what else to use.

A NEW SLANT ON ANTENNAS

Wherein the Slant Determines the Results—Getting Three-Directional Transmission and Reception From a Single Wire Or Zepp Antenna

By W6WB

WHY is it that an amateur's location is usually situated so that he can hardly, if ever, run his antenna in the direction from which best results are wanted? Take our own location, for example. Here the two best directions are East and West. The antennas should run north and south, should be at least 65 feet long, and the property happens to be only 28 feet wide, in a North-and-South direction. At this point we hear a loud voice from the back row, saying—"why don't you run it to a neighbor's house?" The answer . . . our 500 watts in the antenna has a very bad habit of lighting up the neighbors' lights when they are normally turned off. The mere fact that the neighbors can also draw quarter-inch sparks from the escurcheon of the BCL set adds nothing to the piece of mind of the operator.

The problem was to keep the antenna on our own property, which necessitated that its direction be East and West, exactly opposite to the direction in which we desired to work. As if this were not enough, there is a hill of solid rock not over 600 yards directly to the West.

Many amateurs fail to realize that their half-wave 40-meter antennas have entirely different directional characteristics on 40 meters than on 20. On the lower frequency band the antenna is working as a half-wave antenna and the radiation pattern takes the form of a figure 8, with the loops at right angles to the direction of the ends. On the 20 meters this half-wave antenna becomes a full-wave affair and the radiation pattern, instead of being in the form of a figure 8, is now in the form of an X, with the loops at 45 degrees from the antenna's direction.

There is still some radiation at the former right-angle direction, but it is very small and insignificant compared with the 45-degree loops. Obviously, this means that the directional characteristics on 20 meters are entirely different than on 40.

Let us try to visualize what the figure 8 radiation pattern looks like when a third dimension is added. If we can picture a very thick doughnut which, instead of having a large center hole, has, instead, a mere pin point through which the antenna passes, we have the idea fairly well in mind. If the antenna is equidistant off the ground at both ends, the capacity to ground along the entire antenna is exactly the same and the radiation pattern will suffer little, if any distortion. Of course, the height above ground and the attendant reflection also enter into the picture. If we take a single wire antenna and tilt it so that one end is higher than the other we can, in effect, propagate waves in the direction of the tilt of equal intensity to those of the customary right-angle. The height above ground and the degree of tilt determine the angle of propagation in the same plane as the antenna.

After all, these highly-theoretical considerations of antennas are of extremely limited use to the average amateur. Polarization, sine of the angle and other obscure terms are of no help.

At W6WB two tilted antennas were used, one with the high end facing West, the other with the high end facing East.

During the recent International Tests, dx in all directions being available for testing

(Continued on page 28)

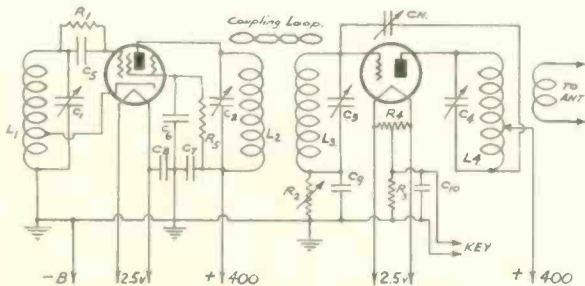

Circuit diagram of newcomers transmitter

LIST OF PARTS

C1, C2, C3, C4—.0001 mfd. Hammarlund Star Midget Condensers.
CN—3 plate Hammarlund Star Midget.
C5—.00025 Sanyo fixed Condenser.
C6, C7, C8—.006 Postage Stamp Mica Condensers.
C9—Condenser across C-Bias Resistor—.006.
C10—Condenser across key—1 mfd. 600 volts.
A .006 Condenser should also be connected between high voltage and ground.

R1—30,000 ohms, 5 watt.
R2—Variable resistance, 0-100,000 ohms.
R3—Variable resistor, 0-10,000 ohms, 10 watt.
R4—Center-tap resistor, Electrad, 50 ohms each side.
R5—30,000 ohms, 10-watt.
L1, L2, L3, L4—Each 30 turns, No. 22 DCC wire, close wound, on Hammarlund Isolantite coil forms, 5-prong type.
Cathode Winding on L1 and Neutralizing tap on L4 go to prong on socket.

The 865 and the 800 In a New Unit-Type Transmitter

By CLAYTON F. BANE



A complete medium-power transmitter with 47 oscillator, 865 doubler-buffer, 210 buffer and 800 amplifier. The 800 stage can drive an HK-354 Gammatron with ease.

SOME months ago when we first presented the 800 to our readers we promised to show a unit wherein this tube could be used to its best possible advantage. Here is the unit.

The 800 was the grand-daddy of all transmitting tubes with horns, ears and helmets coming out from every possible direction. No longer could ye poor scribe design a transmitter along the good, old conventional lines. When he decided to connect the plate lead to the base, lo!—there was no plate. The grid lead followed suit. Obviously something had to be suspended in air.

Hence the strange-appearing modernistic design shown in the photographs. While it is eccentric in the extreme, this design nevertheless takes advantage of this new type of tube by making for exceptionally short grid and plate leads.

The unit is built entirely of wood and Masonite, which is permissible because all RF-carrying leads and coils are mounted away from the panels by the use of the new Birnbach porcelain insulators.

Note also the top supporting panel with its large hole through which the 800 protrudes. This hole is made large enough to have at least 2 3/4-in. clearance all around so that a free circulation of air is possible. This is essential with a tube having an envelope of such small proportions and comparatively high plate dissipation. This top panel is really not necessary, although if it were not used, two side supports would still have to be used to keep the side panels rigid. We preferred to use the top panel with a vent, because it also provides a means for mount-

ing the neutralizing condenser in the most convenient position.

Attention is called to the Birnbach insulators which pass through the top and side panels of the 800 stage. Plugs are fitted to these insulators to support the new General Radio coil forms. This coil assembly is beautifully simple and highly efficient.

A split-stator condenser is used across the plate tank mainly for the purpose of eliminating the very bothersome and costly plate blocking condenser. The fact that it also eliminates hand capacity is an item of no small concern. Since the rotor of the grid tuning condenser is also effectively at ground potential to RF, no hand capacity is experienced when tuning. Unfortunately, there is no system that will eliminate the hand capacity on the neutralizing condenser, a fact which Mr. Cardwell knew when he provided a slotted shaft for the purpose of adjusting this condenser. Both sides of this neutralizing condenser are HOT; do not touch it when the transmitter is in operation.

Radio frequency chokes of the home-made variety are used in both grid and plate leads, not because they are necessary but simply as a precautionary measure to keep stray RF out of the power supply. Most any old choke will serve in these positions.

The photographs tell the constructional story so well that little can be added here to elaborate on the features.

Innumerable combinations have been tried in an attempt to find a proper exciting combination for the 800. The 210 will serve admirably, but only if it, too, is properly excited. We did not exactly favor the idea of having to neutralize two additional stages, so we turned to the 865 for help. This tube works beautifully, directly excited from the 40 meter crystal stage either as a doubler or an amplifier. Its output as a doubler is considerably greater than a 210 or an 841 at the same plate voltage. We used 700 volts on the plates of both the 865 and the 210, from the same power supply.

Resistance bias is used on the 865 to provide a fine bias adjustment for operation as a doubler. A word of caution should be added. It is most essential that the screen of the 865 be by-passed to ground with at least a .006 mfd. mica condenser. The screen voltage was obtained from a series drop resistor, and while this system has some disadvantages it has worked out extremely well in practice.

There is no point in using a screen voltage higher than 150 volts. In fact, if higher voltages are used the tube may be damaged. The screen dropping resistor should have a value of approximately 50,000 ohms, 10 watt size. By-passing the screen to ground is essential, if oscillation is to be avoided. It should also be remembered that coupling between the

grid and plate stages, particularly when working on the same frequency, should be minimized. In some cases it may be necessary to shield these stages from one another. When coupling from the 865 stage into the 210, the 865 coupling loop will probably be best placed toward the cold end of the plate coil. The loop on the grid coil is approximately around the center. This exact same position of the loops exists between the crystal plate tank and the 865 grid tank.

Coupling from the 210 to the 800 stage, the coupling loop is placed around the center of the 800 grid coil. The other end of the coupling loop is rather loosely coupled to the plate end of the plate coil of the 210 tube.

The exciter stage for the 800 uses vertical plug-in coils which lend themselves admirably to the use of fixed coupling loops as described elsewhere in this issue. The coils for the crystal and 865 stage are wound on 1 1/2-in. bakelite tubing, 4 inches long. The 210 coil is a 2 1/4-in. dia. bakelite tube, wound with No. 12 enameled wire. A split-stator condenser is also used in the 210 stage but in this case it was found necessary to add a plate blocking condenser in order to get complete neutralization. This is undoubtedly due to our particular layout and, in general, this condenser would not be required.

The crystal plate condenser and the 865 grid condenser are both small midgets, the other condensers being Cardwell Featherweights, with the exception of the condenser in the final stage, which is a large Cardwell split-stator double-spaced condenser of 50 mmf. per section.

These two units are the exciter units for the HK354 Gammatron stage described in January "RADIO".

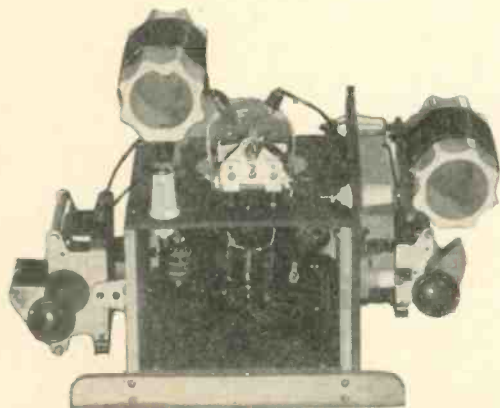

Rear view of the 800 stage. Note the extreme compactness, the unusually short leads and the convenient placing of the General Radio coil forms. The new Birnbach insulators help reduce the length of leads. Note how these insulators protrude through the panels.



Front view. The neutralizing condenser, a small Cardwell, is mounted on the "upper deck". The Cardwell grid coil tuning condenser is at the right, the plate tuning condenser at the left.

The Mixer Monitor

For C. W. or Phone Transmission

By G. F. LAMPKIN, W8ALK*

HERE is a new kind of monitor for the ham station. It borrows a little from amateur, broadcast-transmitting, and sound-pickup practice—for it monitors either CW or phone transmissions, picks up energy directly as it goes into the antenna, and gives loudspeaker signals that can be put into the receiver phones by audio mixing. Hence the name, mixer monitor.

On any CW transmitter the monitor gives a strong, steady tone output for any frequency band, although it uses no plug-in coils. On any phone transmitter the monitor "plays back" what goes on the air, at any desired volume level, and in addition can be used to instantly show up over-modulation. Finally, the monitor may, without change, be used as a code practice oscillator. Thus it has an appeal to one at any stage of the game—as beginner, as CW expert, or as phone hound.

Unlike the more usual type of RF monitor, the mixer monitor does not use a shielded RF oscillator with self-contained batteries, and producing an R3 to R4 chirp. Rather, it is a 1000-cycle audio oscillator that is automatically keyed by the CW signals. It needs no shielding, and takes power directly from the receiver to which its output is mixed. For CW monitoring, the audio oscillator feeds the grid of a linear detector which, however, is biased for zero output. A small RF voltage picked up off the output tank of the transmitter also is impressed on the detector, so that when the key is down the tube bias is swung up into the operating region and the audio signal goes through to the phones.

Admittedly, the mixer monitor gives no indication of the character of the emitted RF wave. In this respect it might more correctly be called a keying monitor than a radiation monitor. It gives an accurate and much-desired reproduction of ones' own signals as they go out on the air, and is a real aid towards clean-cut keying and operating in general.

In Fig. 1 is given the schematic diagram for

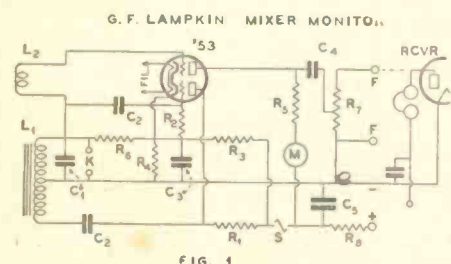

FIG. 1

- L1—Center-tapped output Choke for push-pull 245 tubes
- L2—Pickup Coil for RF, 3 to 7 turns
- C1—.04 mfd. 300-volt
- C2—.01 mfd. 300-volt
- C3—1 mfd. 300-volt
- C4—.25 mfd. 600-volt
- C5—8 mfd. electrolytic, 450-volt
- R1—30,000. R2—30,000. R3—30,000. R4—4000.
- R5—30,000. R6—1000. R7—250,000. R8—5000.
- S—Oscillator ON-OFF switch
- K—Tip jacks for key
- R7—Centralab Midget Variable (All other resistors 1-watt metallized)
- F—Tip jacks for phones
- M—Milliammeter, DC 0-5

the monitor. Although the audio oscillator and linear detector are separate parts of the circuit, only one tube of the twin 53, 79, or

19, types, is required. The constants given off on the top triode, drawing current through the bias resistor R4. The output of the top triode, or linear detector, is resistance-capacity coupled to the volume control. The latter apply particularly to the 53 tube. It will be seen that the lower triode in the diagram is the audio oscillator, using the 245 push-pull output choke as the tank inductance and C1 the tank condenser, with shunt plate feed through R1 and grid-leak bias through R2.

required to give 3 milliamperes detector current, or less, without modulation.

So long as the transmitter is correctly modulated, the DC meter reading will not change. In the modulation process as transferred to the linear detector, an audio voice current is superimposed on a steady direct current. The meter used in the plate circuit will not deflect to ordinary voice currents, but continues to read only the DC. If the modulation on the transmitter for any reason is not sym-

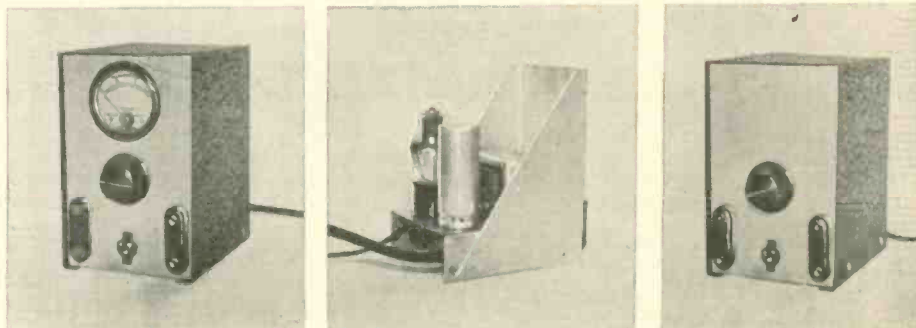

Exterior and Interior Views of The Lampkin Mixer-Monitor

The resistor R3 is a bleeder for complete cut-off is arranged so that negligible load at any setting is placed across the phones in the receiver output.

If desired, a double-pole double-throw switch may be installed in the conventional manner to throw the phones from receiver to monitor and vice versa. Usually, however, it will be much more convenient to use the "mixer" connection, simply by running one wire from the high side of the volume control to the high side of the receiver phones, or speaker, as indicated. There will be no reaction on the receiver, and the monitor output can be cut off at will by means of the volume control. A very nice break-in arrangement is allowed for in this manner; and, so far as the mixer monitor itself is concerned, it works just as well for phone as for CW.

Some measure of control over the frequency of the audio note can be had by adjusting the coupling to the CW transmitter. Grid current in the detector can be made to flow, which, passing down through the iron-cored tank coil, changes the inductance and so the oscillator frequency. The limit to the control is set either by reaction on the transmitter, or by increase of the DC plate current in the detector to a value that produces disagreeable thumps and clicks in the phones when keyed on and off.

The 1000-ohm resistor R6 is provided for use with a key to lower the cathode bias on the blocked detector, so that simply by plugging a key into the tip jacks an excellent code practice oscillator is had.

On phone transmitters the mixer monitor should be provided with a meter in the plate of the detector triode. The oscillator is of course not needed and is cut off with the switch. The rectification characteristic of a typical monitor is given in Fig. 2. From it may be noted that saturation occurs around 6 milliamperes, below which the characteristic is linear. Therefore, the coupling to the phone transmitter should be no closer than

metrical the average value of the detector plate current does change and the meter will deflect, or kick. Probably the most common form of a symmetrical modulation is over-modulation, others being caused by amplifier saturation, insufficient amplifier excitation, and so on—all of which would be registered. The method is inherently sensitive and quick acting. It might be described as a trigger-alarm type of overmodulation indicator as distinguished from the maximum deflection types (volume indicator or RF-current meter). Inspection of the circuit will show that the mixer-monitor volume control setting will have no effect on the detector plate current reading.

It must be remembered that even though the direct current should not jump or kick up to 100 per cent modulation, the RF an-

(Continued on page 35)

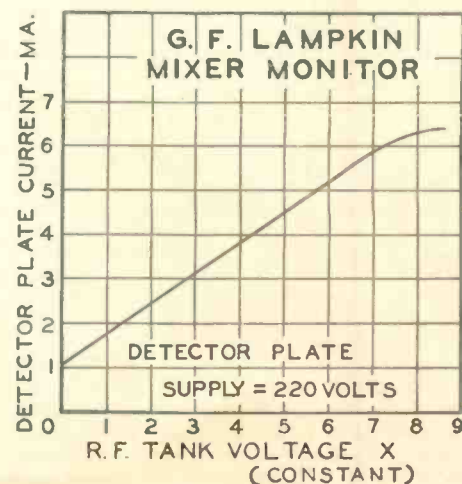

FIG. 2

* G. F. Lampkin Laboratories, Cincinnati, Ohio.

Converting the S-W-3 Into a Super-Het By Means of the New McMurdo Silver I. F. Unit

By FARRELL LEWIS

A GREAT many users of the SW-3 Tuned RF Short Wave Receiver have written to us asking how this receiver can be used as the high-frequency portion of a superheterodyne. Heretofore the complications of building a really efficient intermediate frequency unit have largely been a deterrent to such a conversion. With the advent of the new McMurdo Silver IF Unit which, incidentally, was designed by the staff of "RADIO" in conjunction with Mr. Silver, the prospects have taken on a brighter hue.

There are two possible combinations in the revision of the SW-3. The radio frequency stage could be converted into an oscillator of the electron type with a minimum of difficulty, the detector remaining practically the same. While this is unquestionably the simplest method it is not the best. There is every reason to believe that without pre-selection the final superheterodyne's performance would be greatly hindered by excessive image interference.

We have in the SW-3 a really efficient stage of tuned-radio-frequency making for excellent pre-selection, and it is a very simple method to make a few minor changes in the detector circuit to change this circuit into an efficient power detector. This latter type of detection is unquestionably the most efficient for the mixer stage.

In this particular receiver the RF and detector are already ganged and this ganging need not be disturbed in any way. This is in contrast to the first-mentioned possibility where the oscillator, having to be considerably away from the frequency of the detector, might well add bad ganging complications. Of course, by retaining the original RF stage we must be content with a two dial receiver, since a separate beat oscillator must be added to the existing receiver in order to make this unit function properly.

The tuned-radio-frequency stage circuit has been left unchanged . . . antenna coupling, trimmer and all. The grid condenser and grid leak in the detector circuit have been removed since, as was previously mentioned, this type of detection is undesirable. As we have pointed out in several past articles on superheterodynes, we do not like the tickler (for regeneration) to be placed in the plate lead of the detector because the IF component is in this plate circuit. While perhaps this may not cause trouble, it is felt that placing the tickler in the cathode lead is a much safer proposition.

The same winding that was used for the tickler in the plate circuit can be used in the cathode circuit. It is well to mention that the lead of this winding nearest to the ground side of the grid coil should go to the cathode. Both windings should be wound in the same direction, or, putting it in another way, the winding should be continuous with the exception that the lead is broken at the number of turns corresponding to those of the grid coil and one lead is brought to ground while the other goes to the cathode.

No power detector should ever be designed with a fixed bias resistor. We have recently found that very great improvement has been experienced in a popular model of superheterodyne by changing the existent fixed resistor to one which is variable. Proper adjusting of this variable resistor has been instrumental in decreasing the noise and in-

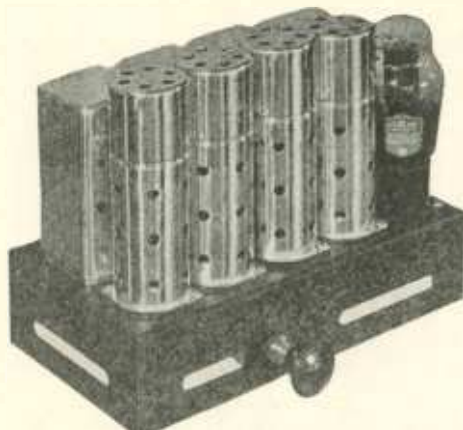

Connect this new McMurdo-Silver IF Unit to your S-W-3, make a few changes in the wiring . . . and you have a Superheterodyne!

creasing the signal by really startling amounts. This resistor is shown as R1 in the circuit diagram and should be a 1500 to 2000 ohm variable.

The oscillator circuit is the conventional Dow Electron Coupled circuit with series band-spread which we have advocated in practically all of our receiver designs for the past year. Its performance, operation and adjustment are so well known as to make further mention needless.

It will be seen that the coupling from the oscillator to the mixer tube is to the screen of this latter tube through a coupling condenser. Both plate and screen leads are shunt-fed through small RF chokes. Needless to say, these chokes must be of a good grade and it is unhesitatingly advised that either the new Hammarlund or National chokes be used.

The McMurdo Silver IF Unit, if purchased completely wired, is ready to go with the simple addition of an output impedance for the 2A5 and a dropping resistor for the screen voltage of the IF stages. This unit is pro-

vided with a beat frequency oscillator which, in turn, has an on-off switch on the front of the chassis allowing the operator to receive either phone or CW signals at will. A gain control is also provided in the IF stages, this control being accessible and variable from the front of the chassis. Air Tuned units are used in the IF, second detector, BFO, and these condensers are readily accessible from underneath the chassis and tune so sharply as to make rough lining-up by ear alone not the improbability which it may seem. Of course, a suitable output meter and oscillator should be used to line-up the stages if the best performance is to be expected. Your friend, the serviceman, is equipped to do this lining-up for you if you do not have the necessary equipment.

The tube complement of the McMurdo-Silver IF Unit consists of two 58's as IF amplifiers, a 56 as second detector, a 57 BFO and a 2A5 power pentode audio. The performance of this unit is really remarkable and is in no way inferior to any IF unit we have ever built. Its use is unhesitatingly recommended.

It will be seen that we have retained the original method of controlling regeneration in the detector circuit. This method is an excellent one and it would be difficult to improve on it.

The gain due to regeneration is very much worthwhile, even though it must be admitted that regeneration in the detector stage will cause a slight increase in noise.

We can think of nothing that will allow the use of the audio stage now in the SW-3, since the IF unit already has a very excellent resistance coupled audio stage of its own with enough gain to please the most discriminating. In fact, the entire IF Unit will provide so much gain that it is very unhealthy for a pair of earphones with the volume turned any way near full on.

The combination illustrated in this article is a perfectly good workable affair and if the instructions are closely followed the performance will be genuinely satisfactory to those who use it.

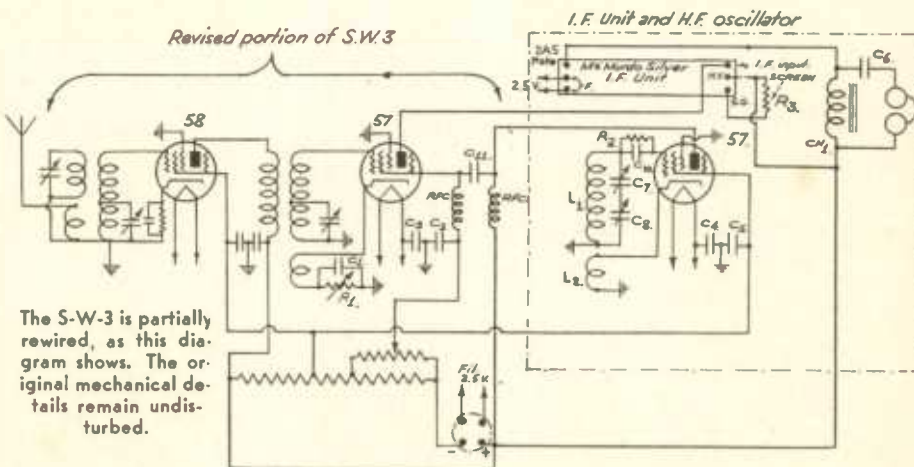

LEGEND
C1, C2, C3, C4, C5—.01 mfd. fixed condensers.
C—1 mfd.
C7, C8—100 mmf. variable midgets.
C10—.00025 mfd. mica.
C11—.0001 mfd. mica.

L1, L2—Standard National coils.
CH1—15 to 30 henry AF choke, 50 mills.
R1—2,000 ohm variable resistor.
R2—50,000 ohm fixed resistor.
R3—25,000 ohm fixed resistor.

The International Tests

By W6WB and W6DZZ



The ninth day of the Tests

WELL, the mad scramble is history. All the months of planning and plotting on how to get that big antenna on friend BCL's house are over. Blown filter—smoke charred transformers—operators with rings under their eyes like the Turkish Crescent—yep, it's all over.

This year, by way of contrast, practically all of the foreign stations seemed to be aware of the fact that there was a test being conducted and no time had to be wasted in telling some chap who didn't speak much of the language about the rules and what it was all about. By no means was this general participation confined to the countries outside the U. S. There were more stations on during these tests than we have heard for years. Somehow it made you experience the same sensation that we all had in the beginning of 1929—when we had to vacate our old stamping grounds and move into quarters very much more cramped. 14 MC again proves its value. This band sounded like 7 MC on a good Saturday night. On the Pacific Coast, Asian and Australian stations were coming in for the first time this year and we heard many European QSO's by Eastern stations.

The tremendous scores piled up by some of the U. S. stations attest to the fact the DX was rather exceptional. We have tried to collect some scores so that we could present them to you. W1ZI apparently leads all comers with the overwhelming score of 23,000! Can you imagine such a score? W1FH can, because he chalked up a score of 19,000! W8CRA would think nothing of it, having 18,000 points. We have not had much time to collect full data on all the scores and it is entirely possible that one or more stations may have even greater scores, although this is very problematical.

Were You Listening When . . .

VP5PZ called CQ, Test . . . no USA stations? How could you, John? When ON4AD came through on the West Coast on 7 MC for one solid hour QSA 5 and did the gang scramble for the key when he signed over?

. . . the Coast Gang nearly went crazy calling XU1A . . . even W6QD joined in the melee . . . and didn't raise him either . . . !

. . . many of the local boys who couldn't raise their hats decided to spoil some of the contest aspirants and carried on lengthy local QSO's at all times of night. Cricket, what?

. . . VP9R in Bermuda came through . . . first Bermudan station we have ever heard in this neck of the woods.

. . . many of the gang were so anxious to raise K5AF that they totally disregarded the fact that he was QSO somebody and kept right on calling him.

. . . LU3—sent out one of his famous "bubbling water" CQ's. Could you get what he said? We have learned only through years of practice.

. . . F3MTA gave all the W's the go-by and CQ'ed VE only. Incidentally, no VE's came back! We only hear this station once a year . . . during the tests. Wonder if he gets on only for the tests?

. . . When K6—sent out a QST long before the contest was over announcing that the tests were over and that no one should take any more test numbers. Reminds us of last year when right after the end of the test, a station that we had called all week came back to our CQ and gave us a number. He was highly indignant when we refused.

. . . the tests ended and some of the gang were still merrily calling test. Darn these sun dials!

A resume of the most consistent stations heard at our station follows:

Europe—G5BY the most consistent and F8PZ the loudest (r6-7).

Asia—J2LN ex J1GA and J2GX ex J1DO. Both these stations were R8-9 on 7 and 14 MC.

Africa—ZS2A all alone, both in the evening and the other way around in the morning.

Australia—VK3WL and VK5HG. This is a hard one to pick since so many of the VK's were fine all during the tests. ZL4AI and ZL3AR take the nod from New Zealand, being the loudest stations heard. ZL1AR was the most consistent on both 7 and 14 MC.

South America—Unhesitatingly, HC1LC. Didn't that fist sound strangely like old HC1FG? We wonder!

North America—NY1AB, X1AA, CM2OP, X1AM all vie for first honors.

After a look at the old log, and after taking into consideration all the stations we heard, we are convinced of one thing—it was utterly futile to CQ. All the work was done by calling the foreign stations.

Some unusual work by coast stations includes the working of VU2 by W6EYC—PAOLL by W6BAX, contest winner of three years ago.

We would very much appreciate reports on any unusual DX that has been done throughout the U. S. and the rest of the world. Please send in any dope you may have.

Here is a partial and very incomplete list of some scores that we have been able to gather. No responsibility is taken for the correctness of these scores, nor do we say that the highest in the list are necessarily the highest in the country: W1ZI—23,000; W1FH—19,000; W8CRA—18,000; NY1AB—21,000; G5BY—6600; G2MA—8000; G2BM—3000.

Other last minute reports tell us that W6DSZ hung up a score of 5,000; W6MV, 4,000; W3ZJ, approximately 18,000; W3BBB was WAC during the contest but did not try for a score; W8CRY worked 48 countries and now has a grand total of 93 to his credit. W3BBB tells us that through an error he was stated as not being WAC in a previous issue of "RADIO". The report should have said he WAS WAC.

CALLS HEARD FROM MARCH 1ST ON 40 METERS BY W1CNU

VP9R, NY1AA, NY1AB, CM7LS, CM2OP, CM8US, CM2NA, VK2YO, VK2BK, VK3MR, VK5SU, X1BA, K5AD, K5AF, K4AOP, K4KD, OA4I, HC1JW, CM1ML, VP6CC, K6AKP, ZL3AR, ZL3GM, ZL4AI, T12RC, T12RU, VP4TB, VE4JH, G2TO, G5BY, EA1BB, EA1BC, EA3AN, EA4AH, EA4AV.



The reason why the ham bands were like a graveyard for days after the Tests were over.

EA4BG, EA5BA, EA5BD, EA5BE, EA7BC, EA8AF, EA8AH, EA8GC, F8SQ, F3MTA, CT1AA, CT1EL, CT1EK, D4BBT, D4BIU, D4BKU, D4UAO and ZS2A. Note: VK3MR and VK5SU were heard between 4:45 and 6 p.m. EST. VK3MR was worked by W1DGC and I worked VK5SU. Heard VK3MR and called him but did not hook him.

Ohio Amateurs Want 10-Meter Contacts

FIFTEEN amateurs in Cincinnati and vicinity are now on 10 meters and they are desirous of making contacts with other 10-meter amateurs outside of their district. W8EDX, W8EGQ, W8GBI, W8BRQ, W8FIC, W8FUZ and W8IDF are some of the stations actively working on 10 meters at this time. All of these stations are now using fone, although some of them will soon have high-power CW on 10 meters also. Get in touch with these amateurs if you wish to contact them on 10 meters. They will appreciate hearing from you.

Old Pop Glass-Arm

OLD Pop Glass-Arm heard a hi-pwr W6 fone tell one of those nice polite W5 fone boys that he (the W6) couldn't answer QSL cards. Sez Pop, "I knew that Mike Lizzard couldn't read code and I knew he had a ham put his transmitter together fer him 'n I know he uses a Botten Receiver but dug-gone if I knew he couldn't read 'n rite enough to make out his own QSL cards!"

RADIOTELEPHONY

By LINEAR

THE JUNKBOX SPECIAL, NO. 4

HERE we show a simple and effective phone transmitter which has an output of approximately 25 watts on 1.75 MC, 3.9 MC and 14 MC. This 25 watt carrier is capable of 100 per cent modulation with broadcast quality. This rig will appeal to those who wish to avoid the troubles of class B modulation. The two 250's operate somewhere between class A and class A prime, and their bias and load conditions are not critical. Link coupling is fundamental in this enlightened age, as is the capacity coupled antenna filter. The diagram and the constants speak for themselves and no trouble should be encountered in putting this rig on the air if the usual amount of care is taken to avoid unwanted coupling between the various portions of the transmitter. Keep the audio amplifier well away from the RF amplifier and the power supplies. Some metal shielding, well grounded, might be desirable around the first audio stage if RF feedback bothers the audio channel. L1, L2, L3 and L4 are all alike, except for the excitation and neutralizing taps, and can consist of No. 14 enameled wire wound on Hammarlund Isolantite receiving coil forms. The number of turns will depend on the frequency band in which the set is intended to work. L5 can also be wound on the same type coil form, although most hams will prefer to use copper tubing at this point. All tank coils except L6 are designed for extremely low C. L6 should be designed for medium high C for the frequency used.

The tuning process is simple and straightforward. A small wooden plug, or a spare plug, plugged into J5, will serve to open the plate circuit of the 210 stage while tuning and neutralizing. Because grid leak bias is used for the 210 it is important that the plate voltage be not applied to this stage until it is properly neutralized and excited. 10 to 25 milliamperes of grid current at J4 indicates satisfactory excitation and all the tuning controls should be gone over for maximum grid current at this point, after they have all been tuned to approximate resonance.

The tuning process, step by step, is as follows: A sharp dip in oscillator plate current, as read at J1, while tuning C3, indicates that the stage is oscillating. The tuning condenser should be tuned slightly away from the point of minimum plate current, for best stability. The grid coil L2 is then tuned for maximum grid current, measured at J2. The 46 stage is neutralized by cutting off its plate voltage with a dummy plug at J3 and then adjusting the neutralizing condenser C5 until there is no grid current present at Jack J4. Of course, C6 and C8 must be tuned to approximate resonance first, which can be found by tuning for MAXIMUM current at J4 with the neutralizing condenser C5 all the way out. After the 46 stage is neutralized, apply plate voltage to this stage and trim both C6 and C8 for maximum grid current at J4. With the antenna load tap LT disconnected we are ready to proceed with the 210 stage.

The 210 stage is neutralized by means of C10. As C11 is rotated a point will be found which affects the grid current at J4. Vary C10 until a point is found where no variation in the current at J4 occurs when C11 is tuned through resonance. This point represents perfect neutralization. Some stages absolutely refuse to be neutralized until C12 is made .01 ufd. However, the .006 ufd. shown should be satisfactory 99 per cent of the time, and has less by-passing effect on the high audio frequencies.

Now that the 210 stage is neutralized and properly excited, (15 or more mills of grid current) we can remove our dummy plug from J5 and thus apply plate voltage. C11 should be tuned for minimum plate current measured at J5. Due to the fact that the antenna load tap is not connected, this minimum plate current will be quite low. Once C11 is tuned to resonance, never touch it again after the antenna load tap is connected. If it should become necessary to retune the transmitter it is essential to remove the load tap LT from the 210 tank circuit before attempting to find resonance with C11. After C11 is resonated, clip the load tap LT on to the plate tank about halfway between the center-tap and the neutralizing end. C14 tunes the antenna circuit to resonance and C15 varies the coupling between the plate circuit and the antenna. The first step is to set C15 at about half its total capacity, then tune C14 to resonance, as indicated by minimum mills at J5. These minimum mills will probably be either more or less than the 60 milliamperes recommended for the 210 stage. The 210 plate current is varied by adjusting the coupling to the load (Antenna). Vary C15

slightly and retune C14 to resonance. Continue alternately varying C15 and then restoring resonance by means of C14 until the minimum plate current of the 210 is about 60 milliamperes.

Now check the audio channel by measuring the plate current at J7. The important thing to remember about J7 is that there should be absolutely no variation while talking. Any variation usually indicates improper bias on either or both of the two 56's. Now plug in the meter at J6. The plate current should increase about 50 milliamperes on the voice peaks.

You are now ready to go after your WAC on phone.

A few reminders. A good ground is essential. It can take the form of a busbar of heavy copper ribbon, running the length of the transmitter. The ground connected to C12 should go as directly as possible to your external ground. There should be no variation in current as measured at any of the jacks, during modulation, with the exception of the modulator plate current measured at J6. Any variation at J5 indicates carrier shift and is

usually caused by insufficient excitation to the 210 stage, poor neutralization or RF feedback to the oscillator or buffer stages from the 210 stage or the antenna.

The best way to get this transmitter working satisfactorily is to build it up one stage at a time. Get each stage working properly before adding the next one. Don't try to mix the RF and audio until both portions of the rig work well alone. The RF stages can be tested in a monitor for freedom from hum and other background noise. The CW note MUST be pure xtal DC before we can expect to get good phone results. Likewise the audio channel should be tested on music, either from records and a pick-up, or from the output of a BCL set. A speaker or phones can be shunted across part of a husky resistor of about 10,000 ohms in place, temporarily, of R13. The quality should be as good as the better grade of midget BCL sets. Something better than this is desirable, but will depend on the quality of the audio transformers used. Only after both portions of the rig are working satisfactorily can we couple up the audio to the RF carrier and expect to step out.

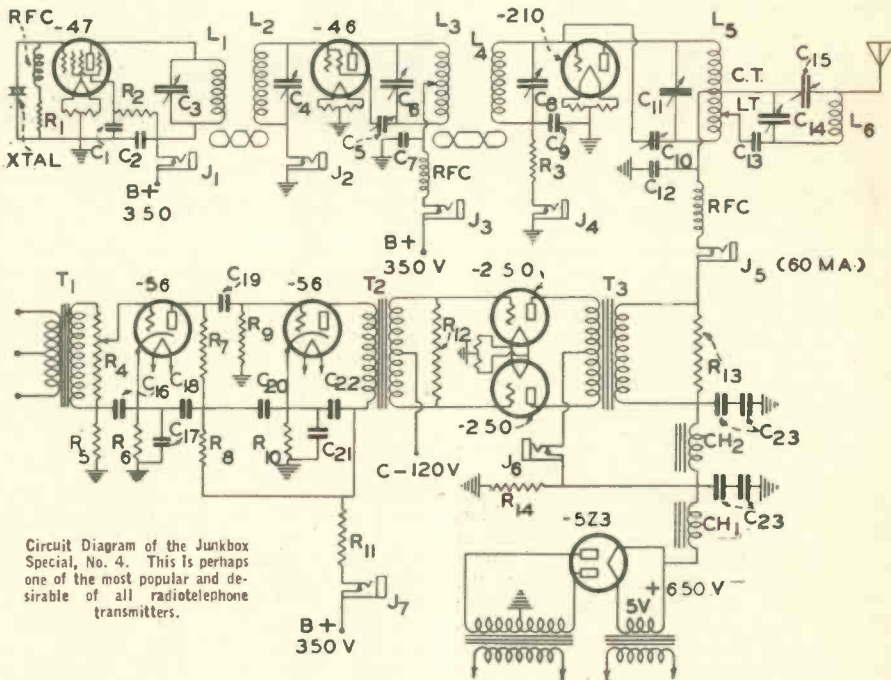

Circuit Diagram of the Junkbox Special, No. 4. This is perhaps one of the most popular and desirable of all radiotelephone transmitters.

LIST OF PARTS

- R1—Oscillator grid leak, 10,000 to 50,000 ohms. Smaller the better, 2 watt.
- R2—Screen dropping resistor, 30,000 ohms, 2 watt.
- R3—Final grid leak, 15,000 ohms, 25 watt.
- R4—Volume control, 200,000 ohms, tapered potentiometer.
- R5—Grid decoupling, 100,000 ohms, metallized.
- R6—56 bias resistor, 2500 ohms, 2 watt.
- R7—Shunt feed, 100,000 ohms, 5 watt.
- R8—Plate decoupling, 10,000 ohms, 5 watt.
- R9—Grid load, 500,000 ohms, metallized.
- R10—56 cathode bias, 2500 ohms, 2 watt.
- R11—Isolating, 5,000 ohms, 5 watt.
- R12—Grid load, 200,000 ohms, metallized.
- R13—Load stabilizer, 100,000 ohms, 10 watt.
- R14—Bleeder, 30,000 ohms, 100 watt.
- C1—.001 ufd.
- C2—Same as C1.
- C3—50 ufd. midget variable.
- C4—Same as C3.
- C5—Same as C3.
- C6—Same as C3.
- C7—.001 ufd. same as C1.
- C8—Same as C3.
- C9—Same as C1.
- C10—35 ufd. variable neutralizing, 2000 V. breakdown.
- C11—50 ufd. variable tank, 2000 V. breakdown.
- C12—.006 fixed, 2500 V. breakdown. Mica.
- C13—.006 ufd. 2500 V. same as C12.
- C14—350 ufd. variable. (Good BC cond.)
- C15—Same as C14.
- C16—Anything from 1/2 to 2 ufd.
- C17—Same as C16.
- C18—Same as C16.
- C19—Same as C1.
- C20—Same as C16.
- C21—Same as C16.
- C22—Same as C16.
- C23—Filter conds., each 16 ufd., 350 volts, making 8 ufd. 700 V. in series.
- T1—Mike to grid transformer. United Trans. Corp. No. PA134.
- T2—Plate to push-pull grids. United Trans. Corp. No. PA132.
- T3—Class A prime output, 1.25 to 1 stepdown. UTC No. PA20.
- CH1—First filter choke. 15 henries 200 MA. Low resistance. Can be swinging choke. UTC No. PA41.
- CH2—30 henries or more at 75 MA. UTC No. PA44.

Two power transformers necessary. One 650 to 800 volts center-tapped BC type. UTC PA22. One 1200 to 1400 volts center-tapped, @ 200 MA. Must have good voltage regulation. UTC No. LS74 or LS75.

Warner Hobdy, W6MV Wins Radio Pentathlon

YOU have heard of electrons, audiotrons, gammatrons and other kinds of trons, but now comes the Radio Pentathlon. It is not a new tube nor a new invisible ray, but it is an annual five-event athletic meet. The boys of the San Francisco Recreation Commission vie with the boys of the Palama

Station W6MV, San Francisco. An 852 drives a pair of Gammatrons in the final. W6MV also piled up a neat score in the Internationals.

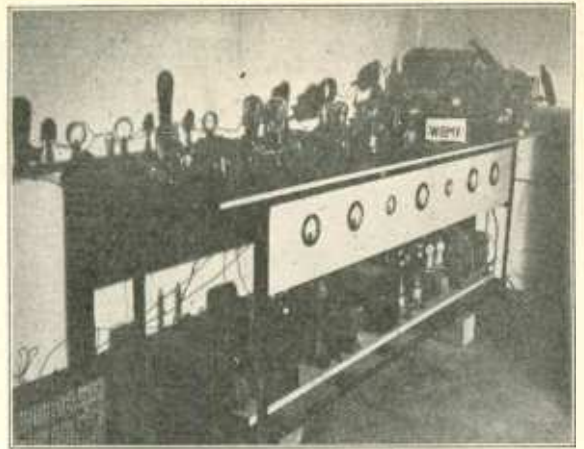

"An old, old man, with an old, old pipel" Warner Hobdy, W6MV, who was awarded a silver cup in recognition of his splendid amateur communication work during the recent Hawaiian-San Francisco Radio Pentathlon.

Settlement Boys' Club of Honolulu. The scores of the events are sent by amateur radio from Honolulu to San Francisco.

The radio amateur who gives the best account of himself in handling the results of the events is awarded a beautiful silver cup. And the winner this year was Mr. Warner Hobdy, W6MV. The cup was presented to Hobdy by the San Francisco Recreation Commission. Plans for the meet and the radio amateur communication link were perfected by A. F. Hoeflich and Chas. Vanoncini. It is hoped that a similar meet will soon be arranged with radio amateurs in Mexico. Negotiations are already under way.

W6MV-K6BAZ, on 7000 KC, formed one link in the amateur communication chain with Honolulu. WLV-WVBQ had another circuit in operation on 940. W6AWT-K6CIB were on fone, 3900 KC. W6NK-K6CIB on 3500 formed still another link.

The signals from both W6MV and K6BAZ were a consistent R8 during the entire period in which communication was carried on. Contrast this with last year's attempt, when the signals of the same two stations faded out completely from 10 p.m. till 11:15 p.m., PST.

Mr. Hobdy expresses appreciation and

thanks to Jimmy Jaeger for his help in handling the telephone and taking down the results as they were received from Honolulu and from the San Francisco gym. The success of this feat is just another tribute to amateur radio in service, convenience and necessity.

The radiotelephone circuit, W6AWT-K6CIB on 3900, was 100% successful. Mayor Angelo Rossi of San Francisco rolls-royced out to W6AWT's home and spent a pleasant evening with Mr. Molinari (W6AWT). From W6AWT he spoke by amateur fone to Mayor Wright of Honolulu. The mayor was greatly impressed with the reliability of the service and the splendid manner in which the contacts were made by W6AWT-K6CIB.

Incidentally, W6AWT is also a cup winner . . . one of the Hoover cups. He is one of the four amateurs who grace their dens with this trophy. Now that Molinari has a Hoover Cup and Warner Hobdy has been awarded the Silver Cup for his work in the Pentathlon, it seems fitting that these men send invitations to all and sundry so that the gang can have a little ice-cracking party and use these cups to toast the success of amateur radio. Can we come up sometime?

TRANS-PACIFIC ON 7MC By KA1NA

THE W/VE DX Competition held during March 1933 afforded an opportunity to make a study of conditions in the 7 MC band for trans-Pacific work at one particular season of the year. Accordingly, the reports made and received at KA1NA, located about 50 miles N.W. of Manila, have been analyzed and the results are presented here in graphic form. The curves are based on average reports received during each hourly period for the nine days of the contest. The curve marked "KA1NA" represents the signal strength of this station as reported by W-6 and W-7 stations. The curve marked "W6 and W7" represents the signal strength of those stations as received at KA1NA. In order to make the curves representative of conditions between the West Coast and the Philippines, reports exchanged during this contest with stations in other than the W-6 and W-7 districts have been eliminated from the averages and also from the "number of QSOs" curve (the dotted one). This latter curve is not based on averages but represents the total number of QSOs between W-6 or W-7 stations and KA1NA during each hourly period, the ordinate for each period being plotted at the half hour point. For example, 30 such QSO's took place between 0700 and 0800, and 6 between 0500 and 0600.

We have believed that conditions were at an optimum on this band at this approximate distance when there was from 85 to 90%

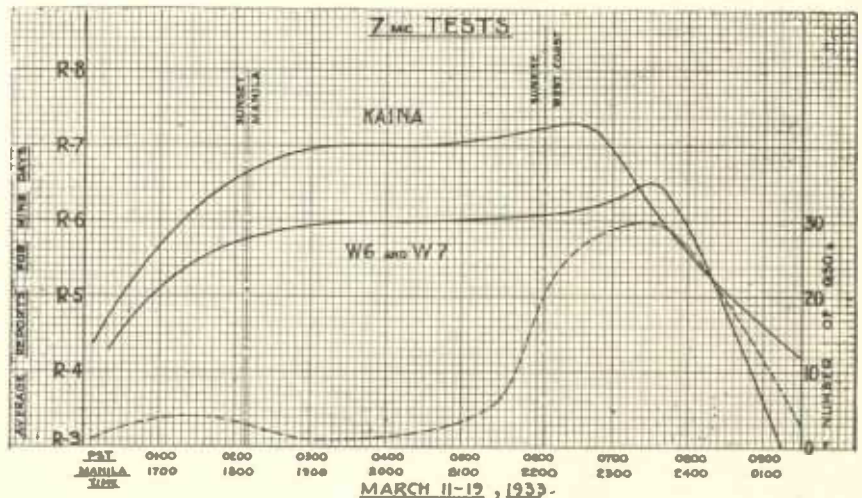

darkness between the stations. The curves indicate maxima at one-half hour (KA1NA) and one hour and a half (W6 and W7) after sunrise on the West Coast, but no such maxima appear at corresponding times before sunset in the Philippines. It is interesting to note that the maximum W6 and W7 signal strength occurred a full hour later than the maximum strength for KA1NA. Also that the peak in the former curve is more pronounced being 8.3% above normal "all-darkness" strength (R-6), while the peak in the KA1NA curve is only 4.3% above its normal

R-7. Another point of interest is that, while there was not much difference in reports given and received during the very early hours (0000 to 0130 PST), a considerable difference existed after 0830. KA1NA's signals were reported R-4 several times after 0930 when no West Coast station could be copied here. This peculiarity had been noticed and reported before the contest and was carefully checked on March 12th and 19th, the two Sundays, when any number of high power "West-Coasters" were on the air after 0900.

(Continued on page 28)

Mis-Matching Impedances for Efficiency— and Why Low C Plate Tank Is Desirable

By C. C. ANDERSON and J. N. A. HAWKINS
A Paper Presented By The Amateur Radio Technical Society

IMPEDEANCE is that characteristic of a circuit element which RESISTS the flow of alternating current. In other words, it **IMPEDES** the flow. It corresponds exactly to RESISTANCE, which impedes the flow of DIRECT current. A resistance is always an impedance, but an impedance is not always an equivalent resistance. By this is meant that practically all pure resistances equally impede the flow of AC and DC, but often one deals with impedances that offer a different impeding effect to AC than to DC. An RF choke is a good example. Its DC resistance is usually small but it materially impedes the flow of AC through it. A condenser is a form of impedance that has the opposite effect. Its resistance to the flow of DC is nearly infinitely high while it offers only a small impedance to the flow of AC.

In the field of Radio Communication we are constantly transferring energy, in the form of AC, from one circuit to another, in order that we may amplify it, or select one frequency and reject all others or radiate it from an antenna, etc. In transferring this AC from one point to another it is essential that it be transferred as effectively as possible, in order to minimize avoidable losses. In order to do this the fundamentals of IMPEDANCE MATCHING must be examined.

Let us start with the device that GENERATES AC. The vacuum tube oscillator or amplifier is just as much a generator as the big alternators that supply the 60 cycle power lines. It takes one form of energy (DC) and changes it to another form (AC of the desired frequency). Its efficiency as a generator of AC is measured by the ratio of DC plate input to the AC power output. This also is called plate efficiency. The DIFFERENCE between the DC plate input and the AC power output is the PLATE LOSS and must be dissipated in the form of heat from the plate of the tube. Because tube cost is almost exactly related to rated plate dissipation, it pays to obtain HIGH PLATE EFFICIENCY as it is then possible to obtain high power output from small tubes.

Let us see what IMPEDANCE has to do with plate efficiency. A vacuum tube AC generator has, as have all AC generators, a definite internal resistance to the flow of current. As we are dealing with AC we shall call it DYNAMIC PLATE IMPEDANCE. It varies with the applied plate voltage and the grid excitation, but for any given set of conditions it can be measured and has a definite impeding effect on the current flowing through the plate circuit of the tube (from plate to cathode, or filament). It has been found, by mathematics and experiment, that certain definite things happen to the power output and efficiency when different values of LOAD IMPEDANCE are coupled to this plate circuit. Fig. 1 shows some curves demonstrating this fact. From those curves we see that, GIVEN A CONSTANT VOLTAGE GENERATOR, THE GENERATOR EFFICIENCY INCREASES AS THE RATIO OF IMPEDANCE MIS-MATCH INCREASES—BUT THE POWER OUTPUT IS MAXIMUM WHEN THE LOAD IMPEDANCE IS MATCHED TO THE INTERNAL IMPEDANCE OF THE GENERATOR.

In all class A amplifier circuits the vacuum

tube acts as a constant voltage generator, because the grid excitation is limited to the straight portion of the tube's characteristic curve. Thus for maximum power output from a class A amplifier the load impedance should equal the dynamic plate resistance (Impedance) of the tube.

Distortion considerations cause us to modify this condition slightly, so we usually try to work a class A amplifier tube into approximately twice its dynamic plate resistance.

In the class A prime circuit the grid excitation can be increased by going beyond the

straight portion of the characteristic curve up to zero bias and down nearly to cut-off. The resulting harmonic distortion is largely neutralized by the use of the push-pull circuit, so that all the even harmonics tend to cancel out. However, in class A rime the load impedance is usually made as great as four or five times the internal plate resistance so that higher EFFICIENCY may be gained. In a well-designed class A prime amplifier it is possible to obtain plate efficiencies in the neighborhood of 40%, while in true class A 22% is considered high efficiency.

The question arises, "we get higher plate efficiency by mis-matching the plate and load impedances, but has not our power output declined"? From the power curve in Fig. 1 it looks as if the power output, when the mismatch is 5 to 1, declines to only 55% of that available when the plate and load impedances are equal.

Quite right, BUT note that the rule and curves apply to CONSTANT VOLTAGE GENERATORS. The class A prime amplifier is not a constant voltage AC generator, like the true class A amplifier. By increasing the plate voltage and the grid excitation we have increased the voltage output (and therefore, the power output) so that the whole power output curve must be bodily shifted upward on the curve, while the efficiency curve stays where it is. Thus plate efficiency is increased without sacrificing power output.

The Class C RF Amplifier

THE most important use for impedance mis-matching is found in the class C radio frequency amplifier, as used in the final amplifier of an amateur transmitter. Here we want high plate efficiency and high power output at the same time, which is seemingly impossible from a study of the curves shown in Fig. 1. We again ask you to keep in mind the fact that the curves are for constant voltage generators, and also to remember that the class C amplifier is NOT a constant voltage generator, if certain things are done to it.

You were told above that a vacuum tube AC generator is the equivalent of a source of AC in series with a resistance whose impedance is equal to the dynamic plate impedance of the tube. It is this impedance that is matched or mis-matched to the load impedance.

The units or terms which are used to measure AC phenomena are chosen so that, under certain conditions, DC elements may be used to replace the AC elements in the circuit, without disturbing the voltage, current and power distributions. This fact aids in analyzing AC circuits, because DC resistance and power calculations are very simple.

In all AC circuits, the AC with DC and the impedances could be replaced with pure resistances except for one characteristic of impedances. This characteristic is REACTANCE. This term describes the effect of the impedance on the POWER FACTOR except to say that inductive and capacitive impedances have opposite effects on power factor, and at resonance, their effects cancel out. Therefore, in a class C amplifier working into a tank circuit that is tuned to resonance, at the operating frequency, all the circuit elements can be replaced with equivalent DC

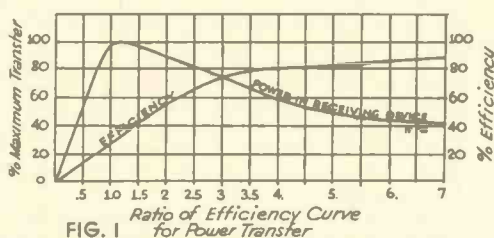

FIG. 1
The comparative percentages of power delivered to a receiving device for various ratios of its resistance to the internal resistance of the supply system and efficiency at which power is supplied to receiving device for same ratios. R_2 equals Resistance of Receiving device. R_1 equals Internal resistance of supply system measured from receiving device terminals.

R_2	% of Max. P_2 $= 100 \times \frac{4R_2 R_1}{(R_1 + R_2)^2}$	% of Efficiency $= \frac{R_1}{R_2} + 1$
.2R ₁	55.6	16.7
.5R ₁	88.9	33.3
.9R ₁	99.7	47.4
1.0R ₁	100.0	50.0
2.0R ₁	88.9	66.7
3.0R ₁	75.0	75.0
4.0R ₁	60.4	80.0
5.0R ₁	55.0	83.0
6.0R ₁	48.9	85.8
7.0R ₁	43.0	87.5

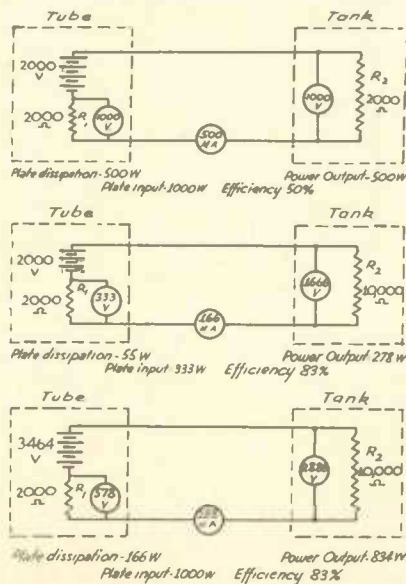

FIG. 2

THE Federal Radio Commission on February 26, 1934, modified Rule 402 by deleting the words "modified or".

Rule 402 as modified reads as follows:

" 402. Proof of Use: Amateur station licenses and/or amateur operator licenses may, upon proper application, be renewed provided: (1) The applicant has used his station to communicate by radio with at least three other amateur stations during the 3-month period prior to the date of submitting the application, or (2) in the case of an applicant possessing only an operator's license, that he has similarly communicated with amateur stations during the same period. Proof of such communication must be included in the application by stating the call letters of the stations with which communication was carried on and the time and date of each communication. Lacking such proof, the applicant will be ineligible for a license for a period of 90 days."

New Products

DETECTIVE Listening in Equipment has started in production at the Universal Microphone Co., Inglewood, Calif., in a specially constructed carrying case. It may be used as a portable outfit or kept in one location as permanent equipment.

Technically the outfit has two stages of amplification, a volume control, a high and low switch, two pairs of earphones and comes supplied with six microphones of ultra sensitive type.

The set is said to be practically fool proof. There are no complicated adjustments. The phones plug in and is ready to operate.



There are 800 feet of lead-in wire which is so small it cannot easily be seen or discovered. The outfit has volume, power and exceptional tonal quality, according to the factory.

The Universal Listening-in Equipment was designed by a police officer and is manufactured in a plant where precision work is an everyday job. It has been developed to sell at a price which places it in a class by itself. The materials are standard.

The double earphones make it possible for a detective and a stenographer, for instance, to listen in on a conversation at the same time. Where police officers are staked out on spots, the instrument will enable them to remain at some distance, although hearing the entire conversation and activity.

Micalite Transmitting Coil Forms With Ribs

A new large-size transmitting coil form, made of MICALITE, has just been released by the Barrett Manufacturing Co., 1382 - 16th Ave., San Francisco, Calif. This new coil-form is 2 1/4-in. diameter, 3-in. long, has eight ribs for low-loss work, and is equipped with a standard 4-prong base. It is known as the TYPE X. It is a convenient coil-form for use in any type of transmitter and its plug-in feature will meet with approval of those who desire to make rapid frequency changes.

circuit elements, and analyze the efficiency and output with nothing more complicated than Ohm's law and the fact that volts times amperes equals watts. In the final amplifier of an amateur transmitter you are interested in the plate efficiency of the tube, and the output power present in the plate tank. (It can generally be assumed that the more power put into the plate tank, the more power in the antenna, which is what we are after).

In Fig. 2 the amplifier tube has been replaced with a battery, whose voltage output is equal to the effective value of the AC voltage generated by the tube. The dynamic plate impedance of the tube is replaced by the resistance R1 and the impedance of the load tank is simulated by R2.

Certain arbitrary values have been chosen which might be considered somewhat typical, although the actual values chosen have nothing to do with the principal involved. In Fig. 2A the 2000 volt battery, in series with the generator impedance of 2000 ohms, supplies a load whose impedance is MATCHED to the generator impedance, and is, therefore, also 2000 ohms. Ohm's law shows that 2000 volts across 4000 ohms forces a current of 500 milliamperes through the resistances. The voltage drop across the generator is equal to that across the load so that the total power of 1000 watts is equally divided between the generator and the load, so the efficiency is 50% and each must dissipate 500 watts.

In Fig. 2B the only change in the circuit is in R2, which has been changed to 10,000 ohms, or five times the internal plate impedance of the generator. Now let us see what has happened. We now have a total of 12,000 ohms across the 2000 volt battery so that only 166 milliamperes flows in the circuit. At 2000 volts, this represents an input of 333 watts. Note, however, that 5% of the voltage drop is across the tank circuit and only 1/5 is across the generator impedance. That indicates that the efficiency has risen to 83%. Fine business! But where, oh where has our power output gone? We may have only had 50% efficiency in the first example, but at least we had 500 watts in the plate tank, and now we only have 278 watts in the plate tank. Efficiency may be desirable, and all that, but it takes watts in the tank and antenna to work that elusive DX. Quite right, so now we come to the answer.

In the first two examples the battery voltage was kept constant at 2000 volts, thus demonstrating the curves shown in Fig. 1. As the efficiency rises, the power output drops, GIVEN A CONSTANT GENERATOR VOLTAGE. How can the generator voltage output be increased? WITH MORE BIAS, EXCITATION AND PLATE VOLTAGE.

In Fig. 2C everything is as it is in Fig. 2B, except that the battery voltage is increased to 3464 volts. 3464 volts was chosen because it makes arithmetic simpler, because the input is exactly 1000 watts again. 3464 volts across 12,000 ohms gives 288 mills and 1 KW, just the same input that we had in Fig. 2A, but note that 5% of the drop is across the plate tank so that the efficiency is still 83% as in Fig. 2B, while the OUTPUT is now 834 WATTS. At the same time the plate dissipation is only 166 watts, so that a pair of 852's or a single Gammatron 354 (running intermittently: i.e., keyed) will give more output than the two 204A's which would have been necessary in the first example in order to dissipate 500 watts from their plates.

Mr. Perrine, W6CUH, and others have done such a good job of showing HOW to get this high plate efficiency that we will confine our remarks on the subject to the above notes on WHY mis-matching improves efficiency. However, in order to get the greatest mismatch, use a tube with the lowest dynamic plate impedance, at the highest voltage that the tube insulation and gas content will al-

low. The high plate voltage also further reduces the internal impedance. Then use all the L and as little C in your plate tank as possible. The antenna coupling should be as loose as it can be, without cutting the input below that desired, and the bias should be around five times cut-off. The excitation, as measured by the DC grid current, should be between 15 and 25% of the DC plate current, and will vary for different types of tubes. In general, the higher the mutual conductance of the amplifier tube, the less excitation power is needed for a given load impedance.

Matching Impedances

NOW let us think about where we must MATCH impedances. After we have decided on the impedance which we wish to REFLECT into our tube's plate circuit, whether it be at audio or radio frequencies, we must MATCH from there on. Fig. 3 shows four transformers between the tube and the load, which is indicated by the resistance R. Whatever the impedance ratios of these transformers may be, they must all match each other so that the load resistance R, when reflected back through all the transformers, must equal whatever load resistance we have decided on for our tube.

In a speech amplifier the primary of the microphone transformer must be matched to the impedance of the microphone, if one wishes to effectively transfer energy from the microphone to the transformer. Also the secondary of the microphone transformer must have an impedance approximately equal to that of the grid circuit into which it delivers the energy it received from the microphone. Any mis-match will not only cause losses but may cause audio distortion which will affect the quality.

In our transmitters, we use link coupling between stages so that we may TRANSFORM the driver plate impedance to a value equal to the dynamic grid impedance of the next stage, in order that the maximum of energy shall be available to excite the grid.

In transmitters that use capacity coupling between stages, we must either choose the tubes so that the plate impedance of the driver stage is approximately equal to the grid impedance of the driven stage, or else tap down on the plate tank in order to get auto-transformer action. Because tapped tanks are bad practice, due to parasitic oscillations, the tubes must be matched directly, or accept the losses that result from improper matching. Generally, it is impossible to get a perfect match with capacity coupling, but an approximate match can be obtained by alternating high and low mu tubes. Thus a 47 oscillator, with its high plate impedance can better drive a 45 buffer, rather than a 46, 841, 47 or 830B. A 45 or 2A3 buffer could then drive a high mu stage (46, 841, 47, 830B or 203A). The point can be expressed in another way. A 47 tube likes to supply a lot of RF volts but few mills. On the other hand, the grid of a 46 requires comparatively few volts but many mills. Thus the 45 or 2A3, which requires more grid volts but less grid mills, for a given output, utilize the output of the 47 oscillator more effectively than do the high mu tubes, when capacitive coupling between stages is used.

Link coupling is so simple and effective, and has so many other advantages over capacitive coupling that, once used, will never be replaced with choke-condenser coupling.

Fine New Amateur Catalog

EVERY amateur who buys by mail will be impressed with the new 90-page catalog just released by Lew Bonn Co., 2484 University Ave., St. Paul, Minnesota. This catalog is chock-full of the kind of things an amateur likes to read about. Within its pages is found a description and price of practically any part that an amateur will need at any time. Drop a line to Rex L. Munger, Sales Engineer of Lew Bonn Co., enclosing a few stamps, and he will send a copy of this new catalog to you.

High Fidelity Audio Transformers

By I. A. MITCHELL
Chief Design Engineer, United Transformer Corp.

THE gradual trend from code to phone over the past few years has brought to the attention of the amateur the great effect of audio transformers on transmitter fidelity. The frequency characteristic of a well-designed audio amplifier is almost entirely controlled by its audio transformers. For really high fidelity reproduction, transformers should have negligible frequency discrimination, from 30 to 15,000 cycles. Some of the design factors governing such transformers are discussed below.

In the design of quality audio transformers, five major factors must be carefully considered. These factors in the order of their commercial importance may be listed as follows:

1. Uniform frequency response
2. Low wave form distortion or phase shift
3. Thorough shielding
4. Dependability
5. Flexibility

As the scope of this article is limited, frequency characteristic alone will be covered. However, it is well to note that the improvement of frequency range has some bearing on all other factors, that is:

(A) In attempting to reduce frequency discrimination by reducing leakage reactances, distributed capacitances, and by the operation of core materials at low flux densities, both wave form distortion and phase shift are reduced considerably.

(B) Due to the greater range of frequency transmission, both magnetic and electrostatic pickup become quite objectionable. The transformers whose frequency curves are illustrated were housed in a casting having five times the permeability or normal cast iron. When transformers are operating at low levels, it is also essential to have a secondary inner metallic shield to minimize electrostatic pickup.

(C) Considerable improvement in frequency range of a standard transformer can often be obtained by reducing the thickness of insulation between winding, thus reducing the leakage reactance; or by poor impregnation of the windings, thus reducing distributed capacitance. This is false economy and engineering of the worst order. Coils should be vacuum impregnated, and so sealed that no adverse humidity conditions can affect them. Winding insulations should be capable of withstanding at least twice the maximum peak potential possible in practice.

(D) In attempting to obtain a number of impedance combinations from one transformer, so that flexibility in service is assured, variation in frequency range will be obtained unless accurate precautions are taken. It is essential that for all impedances available, almost complete coupling of the windings be maintained. This can be done. The transformer whose frequency characteristic is shown in Fig. 5 has six primary impedances and six secondary impedances, the impedance range in both cases being 10 to 1, yet to 25,000 cycles not .5 DB change in loss is obtained for any impedance combination.

Inherently, a transformer is a device presenting a means of transferring power from one circuit to another without any direct connection between these circuits. In simple form, we illustrate in Fig. 1 an ideal transformer, that is a transformer having 100% efficiency. In such a case the power delivered



A section of the Test Laboratory where Audio Transformer design and performance are given the acid test.

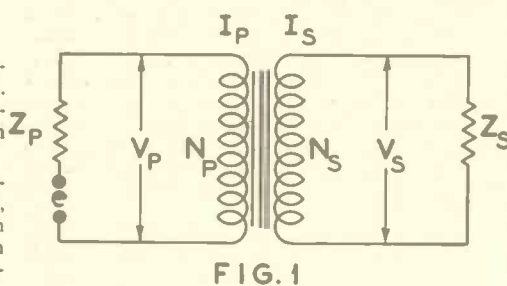

FIG. 1

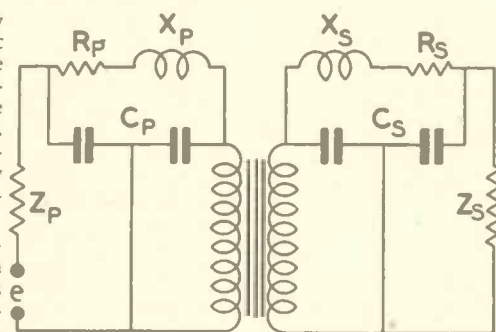

FIG. 2 A

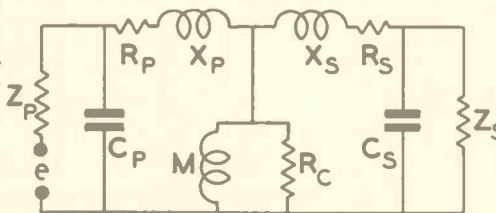

FIG. 2 B

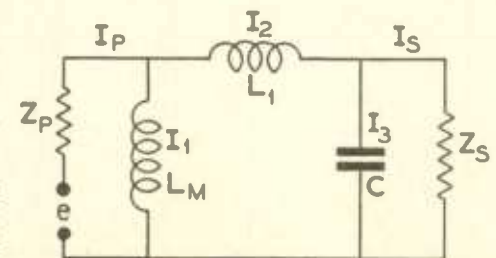

FIG. 3

to the input will equal the power taken from the secondary or

(1) $V_p I_p = V_s I_s$. The basic characteristic formula of a transformer is:

$$(2) \frac{V_p}{V_s} = \frac{N_p}{N_s}$$

combining (1) and (2), we obtain

$$(3) \frac{I_s}{I_p} = \frac{N_p}{N_s}$$

knowing that

$$(4) V_s = I_s Z_s$$

we can substitute (2) and (3), obtaining

$$V_p \frac{N_s}{N_p} = \frac{I_p N_p}{N_s} Z_s$$

Therefore

$$\frac{V_p}{I_p} = Z_p = \frac{N_p^2}{N_s^2} Z_s$$

This result indicates that the impedance ratio of a transformer is directly proportional to the square of the turns, and is the base upon which all impedance matching is done in audio transformers.

Unfortunately, in practice, transformers which are 100% efficient are not obtainable. A physical transformer is illustrated in Fig. 2(a) and its equivalent T network in circuit is shown in Fig. 2(b). Here R_p and R_s are respectively the primary and secondary resistances; X_p and X_s are respectively the primary and secondary leakage reactances; C_p and C_s are respectively the distributed capacitances of the primary and the secondary and their attendant circuits. In a physical transformer, M is not infinite, as some current is taken through the primary circuit with the secondary open. This is the current required to set up the flux in the core. Power is also absorbed in R_c which includes the I^2R losses in the coil windings and a small amount of loss occasioned by the eddy current losses and hysteresis losses in the core. These core losses can be reduced to an inconsiderable value if quality core materials such as the nickel iron alloys and powdered iron are used. The winding resistances are generally of small magnitude and having no frequency discrimination can normally be eliminated. This allows us to simplify our equivalent circuit still further as per figure 3, where the leakage reactance L_1 and distributed capacitance C are lumped.

It is apparent that for uniform frequency transmission in this circuit, I_s should be con-

stant regardless of frequency. If all the impedances in this circuit were non-inductive, such would be the case. Unfortunately, the impedance of an inductance varies directly as frequency and the impedance of a capacitance inversely to frequency. It is therefore seen that as the frequency is reduced, the impedance of L_m will also be decreased and I_1 will be increased. This shunting effect of the primary inductance is the main factor controlling the low frequency response of a transformer. Obviously, the reactance of the transformer primary should be high as compared to the source impedance Z_p at the lowest frequency at which it is to function efficiently. A curve showing the loss due to the shunting effect of the primary of a transformer is illustrated in Fig. 4. As an example of the use of this curve, let us assume source and load impedances of 500 ohms. At the frequency at which the primary reactance is 325 ohms, there would be a 2 DB loss. In other words, to design a transformer having a loss of 2 DB at 20 cycles, the primary inductance would have to be such as to offer an impedance of 325 ohms at 20 cycles.

Examining Fig. 3 once more, it is seen that as the frequency increases L_1 increases in impedance. This naturally throws a series loss in the secondary circuit such that I_2 and the following currents I_a and I_s are reduced. The leakage inductance L_1 is due to imperfect flux coupling between the primary and secondary. If the co-efficient of coupling in the above transformer were .995, the leakage would be .5%. This would be at 20 cycles .5% of 325 ohms or 1.625 ohms. At this frequency, it is evident that the leakage reactance loss is negligible. However, the impedance of L_1 at 20,000 cycles, varying directly with frequency, would be 1625 ohms. Naturally, in a 500 ohm circuit this would be a very great loss.

The distributed capacity C is again effective only at the higher frequencies. Similar to the primary, it is purely a shunting effect varying with frequency. Fig. 5 illustrates the loss due to distributed capacity in an audio circuit. If source and load impedances were 100,000 ohms each, it would require only 300 ufd to cause a loss of 2 DB at 10,000 cycles.

Summarizing the above, we note that on the whole, there are three major factors governing the range of audio transformers, namely, Primary inductance, Distributed capacitance, Leakage reactance.

To increase primary inductance on a given core structure, it is necessary to increase the turns in the winding. Unfortunately, this at the same time increases the distributed capacitance and leakage reactance. It is therefore apparent that in attempting to improve low frequency response we must sacrifice highs, or vice versa. The choice of a balance point depends solely upon the application. However, it has also been found possible to increase the coil inductance by improving the core material so that it has a higher permeability at the flux densities encountered in operation. Research in this field has developed the nickel-iron and other magnetic alloys. The reduction of leakage reactance and distributed capacitance is quite involved. Toroidal and semi-toroidal transformer structures reduce flux leakage and consequent poor coupling, but in addition to this many coil structures require accurate and multiple interleaving of coils. How high this can be extended is seen in the frequency characteristic of the standard line matching transformer illustrated in Fig. 6. The coupling in this transformer exceeds .999. The frequency run of a well-designed output transformer is illustrated in Fig. 7.

Distributed capacitance can be divided up into three cumulative effects: turn to turn capacitance, layer to layer capacitance, and

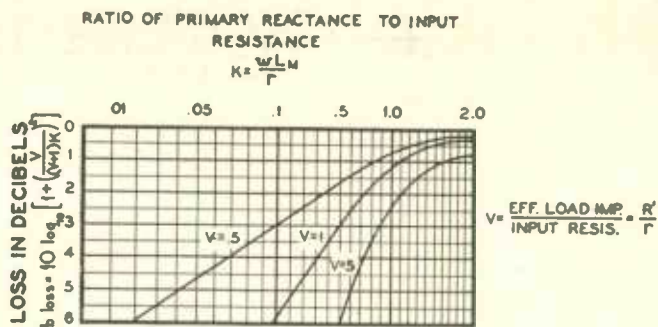

FIG. 4

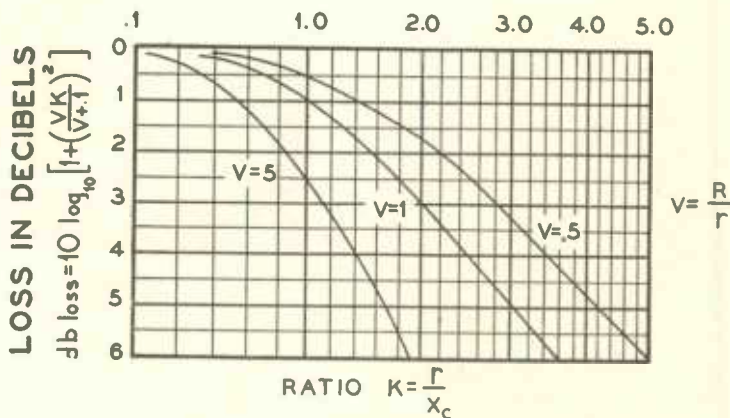

FIG. 5

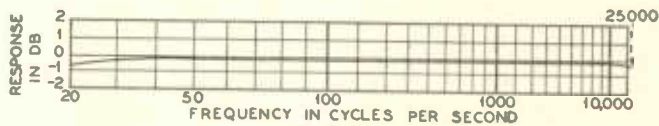

FIG. 6

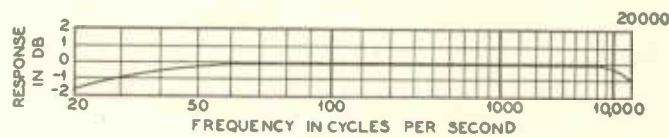

FIG. 7

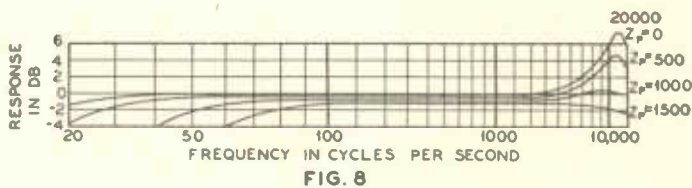

FIG. 8

coil to coil capacitance. In a well-designed coil the layer to layer factor is most important. To keep this at a low value, coils can be sectionalized so that the layer length is kept low. However, this must be done very carefully so as not to increase the leakage reactance. On transformers in which the distributed capacitance is of appreciable effect, such as windings in low level grid circuits, resonant effects will generally occur in the secondary such that an increase in amplification is obtained at certain frequencies. This

is often an advantage providing the distributed capacitance is low enough to effect resonance at a relatively high frequency. Both load resistance and source impedance affect this resonance. Fig. 8 illustrates variation in frequency characteristic against source impedance for a line to grid transformer.

Reviewing the above, it is evident that transformer design is now sufficiently advanced to permit the construction of audio amplifiers with negligible frequency discrimination from 30 to 15,000 cycles.

FROM ONES TO NINES

DOINGS OF THE AMATEURS IN ALL U.S. DISTRICTS

Edited by W. E. McNatt, Jr., W6FEW

THIS department would appreciate a W4, W2, W3 and a W5 volunteering their services in supplying some "dope" from their respective districts. Write this department, care of W6FEW, 557 N. Fourth Street, Covina, Calif.

The first five districts this month are taken back to "Ye Olden Days" (or daze) when K. B. Warner said (referring to the 1927 Washington Convention) "—it will offer many grave problems for amateur radio when it becomes effective the first of next year."

We think that you readers will get an idea as to the advancement through which the ham game has passed through the past six years and also a few reminiscences, which may give you a giggle or two.

Any items which you consider worth mentioning in this department will be appreciated. Send them to the editor, 557 N. 4th St., Covina, Calif.

SIX YEARS AGO, THIS MONTH

1'S 1CDX keeps some real schedules—what's more, he uses 'em. 1BUB is having a picnic with his rig—he alternates between 40 and 80—having good results on both bands. 1AQL is on the air from 6:30 to 7:00 p.m. daily. He tells us that the new call letters for the Queen City Radio Club are 1ARR. New members are coming into the club all the time. Livermore Falls is plenty active. . . It should be with 1AQD, 1AHY, 1AXP, 1IP on the air. 1ASJ worked Europe with his low-powered job—and the traffic game is in the dog house, hi. A new job is keeping 1FP off the air. 1BIG has been working hard to get an organization of USNR men functioning and wants to hear from hams in and around Portland and Bangor. 1IP, 1BFT, 1ALY and 1AEF are enlisting in the USNR. 1BVL, 1AXA, 1ADM, 1ABA, 1ACH, 1BW, 1RY, 1KH, 1WV and 1ON all did themselves proud in the International tests. 1ABA got R8 from New Zealand. 1ACA says 80 is getting as bad as 40 as far as the QRM is concerned—(See, you guys, they were kicking then, hi.)

W2'S—WHEN THEY WERE PLAIN OL' TWO'S . . . WITH NO "W"

2'S 2AT is on the air again, having just recently returned from a trip. 2CP handled traffic with all nine districts and wants it known that 2CP is a C.P. traffic station. C.P. means chemically pure, so guess we poor ragchewers won't have any QSO's with him, boo-hoo!

2DX couldn't have been assigned a more indicative call—he works what his call implies. 2EY still has trouble with the R.I. in getting his license renewed. Ed. Note: See, they were having the same grief then that we are having now—so don't cry too hard about the "Good Old Days". YOW! 2JX works all Europe with an indoor aerial and counterpoise. Whew! W2AOP has a phone job on 180 and is organizing a 180 meter club.

2ABF's antenna likes to play games—particularly. "I'm the antenna that's coming down, coming down, coming down."

2BOW cannot seem to raise any foreigners—maybe his bark is worse than his bite, HAW! 2AVK rebuilt the transmitter and is having fine results. S'prisel!

2KA is still hunting for 80 meter skeds. Good hunting, om.—that is, if you get 'em. 2GX was thrilled with the 20 meter tests. He worked Africans and New Zealanders.

2BY has had several 2nd and 3rd district hams call at HER shack to investigate the "works."

3'S The hams in this state (Delaware) are almost 100% USNR members with the exception of 3SL and 3ALQ, who isn't on the air much. 3AED is heard in nearly all countries. 3WJ rattles the cans of the West Coast gang with his new xtal rig on 38.52 meters. 3AIS is on the air with a fifty watter since his 250 watt bottle went West. His 250 watter will be replaced on the air by 3AUN, who is coming on the air with one of 3ZO's 250 watt bottles. 3AOP is a newcomer to hamdom. 3CAB has signed off indefinitely. 3AKB gets plenty of QRK from the BCLs. 3CO is making an attempt to get on with remote control soon. 3QM proudly announces the arrival of a brand new YL op. 3VF is taking a week off to rebuild his receiver. 3CDS wants skeds for milk-man time. 3LC is looking for dope on a combined 80 and 40 receiver. 3BQP and his new OW are having a great time house hunting. Heheheheheheheheh. 3BBW has been off the air for nearly a month, but is back on wit htwo five watters after all sorts of tube trouble. 3SJ is trying for a commercial ticket. 3BMS blew his fifty watter in the tests but is back on again with an 852. Let's hope he doesn't blow that—what'll he replace it with?—mebbe an '04-A.

4'S 4DQ is going up on 80—there is too much of "Pee OEL, T3eul" for him on 40. 4VH is trying to catch up with 4AB but slipped, hi. 4ADJ is increasing the capacity of his Edison cell power supply. 4OC had fine luck in the International tests. 4EC is now located at New



"SCRATCHI"

Here is the originator of "Scratchi." Do you know him? He's a real old-timer; started in radio twenty years ago. Originated his "Scratchi" yarns while cruising in Oriental waters. Formerly chief operator for one of our great air-way systems. Now chief operator on a New York-San Francisco liner. His name? Those who know him will recognize him from this picture. Let's see how many old-timers can call him by name. A box of assorted Japanese wavelenghts goes to the winner. "Scratchi," as the photograph shows, is taking a snap-shot of the return of prosperity . . . coming over the horizon.

Bern and is temporarily on the air from 4EA, who has a 250 watter. 4OH had trouble with his power supply during the tests.

5'S 5AQX is a new ham in Hot Springs. 5AVA rebuilt. 5JK and 5SS each had their sky-poles blown down. 5AOZ put up a new 30-foot mast especially for the International tests, but to no avail—no results. 5IE is rebuilding to a self rectified TP-TG circuit with 210's. 5NE is interested in 5 meter work, but hasn't yet finished his rig. 5YD is on 20. 5LY is on 43 meters and wants all the gang to listen for him. 5AYB is going strong on 40.2 meters, and 5ANP is also on 40 meters. 5AJJ, who has a radio equipped boat, has put up for the winter. 5FQ has a UV 240 on 40 meters and reports working oh-6AVL. 5AKP is working real DX on 20 meters with a 50 watt Signal Corps tube.

5AX is doing fine work out at Robert's Flying Field. They have a 50 watt job under the call of 5RR. 5AS, the old Morse op, is on 20 with an indoor aerial. 5PD is off the air awaiting the renewal of his license. 5MI is again on the air, this time with a 50 watter.

5SO, Bell and Ansley, are on now with an 852 using 2000 AC on the plate. (Ed. Note: It's a cinch they never thought of the October 1933 ruling in "them thar days").

5AXN is using a 200 watt Telefunken and is doing fine. 5DT is in love and his new name is "Love-bird"—Isn't that cute? 5AKK returns from Atlanta and says the gang there couldn't have treated him more royally. 5JY's receiver battery went West. 5AJP is dormant. 5AYL is doing his bit at Huntsville. 5AR is going to be inactive a bit longer.

Well, gentle (?) reader, all that you have just finished reading took place some six years ago. Seems strange to look back to the days when anything over 250 watts was as rare as a nudist in a clothing store.

You'll find much the same activity going on today, the only changes might be that the fellows are using more power, taller antenna poles, are dropping bigger tubes and are kicking against the Madrid Treaty. (Which isn't a bad idea at all).

We go to the present now with

W6FEW AND SOME OVERLOADS FROM SOUTHERN CALIFORNIA

The Federation of Radio Clubs is considering a petition sent out by the Minneapolis gang. The Minneapolis boys are nobody's fools and aren't letting a lot of propaganda and staid old ideas keep them from demanding their rights. They have the courage to get up and demand to know just what is what. Well, as the old saying goes, "Twent be long now." The fellows who have known about the situation for a long time and who told their fellow hams about it, only to be regarded as a trouble maker, are now having the pleasure of saying "I told you so."

W6BSV, BT6, Redding, says he is going to stay on at CCC for a few months and that he MIGHT be home in June. We'll be mighty glad to have you back in Hollywood, Morry.

W6AUB, formerly of CCC, returned home with a busted filament in one of his best 50 watters—and is he griped.

W6BPU still pounds regularly on his skeds—you couldn't make Howell lose a sked for anything less than a case of life and death. His nearly-a-kilowatt input is sure wreaking havoc with his FB-X. The poor thing gets an awful jolt of RF whenever he hits the bug.

Russ Skeeters, of the Pasadena J. C. gang (well, rather, he's the QSO club adviser), says that "RADIO" gets all his ideas into print just about the time he is ready to announce them. Hi.

Incidentally, the P.J.C. gang have gone semi-exclusive. They limit their membership to an ACTIVE 35 now. That's not a bad idea. Most preferable to have 35 active hams in a club than 70 or 80 inactive ones. The boys are getting ready to get going strong. They have a new rig almost ready to go which will give them operation from 160 meters on down to 10 meters. Both phone and C.W. will be used. It is expected that a couple of 11-Ds will be used in the final.

The Federation of Radio Clubs is to have a hidden transmitter hunt soon, and a lot of good prizes are offered for the first five individual crews who reach the unknown location first. By the time you read this, it will have been held and the next issue of "RADIO" will bring the results to you via this column.

W6DVV just can't keep his tubes working at two or two and a half times their rated voltage. He has a terrible time keeping his ten working as a buffer with just a mere 1200 volts or so on it. Hi. W6EBJ, W6FDM, W6DA, W6FPN and W6CQG are on twenty fone.

W6LM, "Good Speed Corps", of El Monte, has a complete file of QST from its first issue. (BUT, of what use are they to you, G.S.?)

W6FWN has been having "trouble" with his crystal.

W6EC, "Doc" Waters, is a good QSO anytime. He's new ITK pledge.

W6GWX keeps things humming at the Pasadena Short Wave Club.

The South East Radio Experimental Association offers \$3.00 an hour for GOOD speakers. (This club is generally known as the Bell Club).

We wonder what in heck has hapunened to W6FTV. Never hear a cheep out of him anymore. Whassamatter, Ed, no '01-As?

W9OP, John O'Hara, whose "bit" appears in this page, came to Pasadena with the Chicago White Sox for a vacation. He visited W6BPU and had quite a time, all in all, eh Jawn?

W7BYR TELLS US OF ACTIVITY IN AND ABOUT HELENA, MONTANA

W7BDJ is rebuilding his entire station and plans to use a pair of 800's in the final.

W7BI is still inactive. C'mon, OM, 'tis spring!

W7CSG is rigging up a 6 volt plate supply apparatus. Sounds like a "portable" outing to us.

W7BOZ is on 75 meter phone and struggles with the everpresent QRM.

W7BDS is cooperating with the North Dakota gang on the traffic trunk line.

W7CTN has an FB7-X.

W7BIS, Deerledge, is on phone and is getting out fine with a pair of 45's in the final.

W7CEG is using P.P. 46's in his final.

W7AAT has a real crystal note on 80 meters.

W7AMA and W7AQQ, who did fine work in the recent Idaho floods, are still on 75 meter phone.

W7CCR is going back to phone.

W7AYQ is off the air until he finishes his new tri-tet job.

W7AQN has a pair of 830's in the final, while W7AOD has a 500 watter in his final.

W7BIZ has a new outfit. W7CCN has a new QRA.

W7CLG also has a new QRA and is on the air again.

W7COG is organizing the Wyoming traffic net, which includes W7AMV, W7ABO, W7AXG, W7AXG, W7BJS, W7CZY, W7COH and W7CSE.

The Wyoming A.A.R.S. are going strong. The members are W7HX (SNCS), W7AXG, W7ALC, W7AMV, W7BJS, W7COH and W7CSE.

(Continued on page 35)

The Banehawk Super-Heterodyne

By CLAYTON F. BANE and NORRIS HAWKINS

PART IV The IF Amplifier

HAVING achieved something really different in the way of results by a rather radical design of the high-frequency portion of the superheterodyne, it certainly behooves us to take exceptional pains in the design of the IF amplifier, else we will lose what we have gained.

Certainly, any modern superheterodyne is not complete without the addition of a quartz filter ahead of the first IF amplifier. The Banehawk receiver is no exception. Considerable experimenting with quartz filters and observations of many existent receivers incorporating such a system have led us to believe that there still remains much to be done before these filters can be considered really effective. From the standpoint of selectivity, most filters leave little to be desired. It is not from this standpoint that we look for improvement. In our opinion, the new Hammarlund quartz filter is the best of any we have as yet examined, both from the standpoint of gain and selectivity. However, it seems that certain factors have been overlooked in most present-day systems. Practically all superheterodynes show quite a considerable drop in volume when the crystal is in the series position. Most operators have come to accept this drop in volume as a necessary evil of quartz filters and overlook it entirely in the light of superior selectivity and signal-to-noise ratio afforded by the filter. Certain experiments that we are conducting at the present time lead us to believe that this drop in volume can be greatly lessened, if not avoided entirely. If this can be achieved practically, and we believe it can, next month we will present to our readers a crystal filter that not only has less tendency to drop the signal, but one that is actually very much more simple in construction than any yet presented. In any case, the filter is a refinement that can be added at any time to the IF amplifier, so we will discuss the IF amplifier itself at this time.

Reams of material have been written on the comparisons between air and compression-type trimmers for IF transformers. Thinking the matter over logically, air trimming is certainly more desirable. In the first place, an air trimmer is very much easier to adjust than the compression type. Secondly, the losses, though perhaps negligible at the low frequencies used, are generally less because of the better construction and insulation of air condensers. A series of very significant curves was presented some time ago by the Hammarlund company, showing beyond question the superiority of air over mica condensers under wide variations of humidity and mechanical vibration. Looking at the matter from an amateur's viewpoint we prefer air-tuned IF's if for no other reason than the fact that they tune so easily as to make alignment (roughly, of course) possible by ear. To the man who does not happen to have an oscillator this is no small matter. With the crystal filter installed, however, such rough alignment becomes one of those things that we would like to do.

If anyone questions the advantages of Litz intermediates let him consult Terman's "Radio Engineering" for a very revelatory set of curves showing the marked superiority of this wire at low frequencies. It must be remembered that the Q of coils with Litz goes down very rapidly as the frequency increases, and that at IF frequencies above 500 KC Litz is a needless refinement.

Practically all supers have some sort of gain control on the IF stages, generally a resistor in the cathode circuits with which the bias is increased and the sensitivity decreased. Here we would like to make a suggestion that may seem to be a little unusual. It has been our experience that if this IF bias resistor is set and left at the point where the gain is almost optimum and the volume controlled in the audio stage, much better signal to noise ratio will result. It is not intended that the IF amplifier stages should be adjusted to the point where tube noise is such as to drown out a very weak signal, but rather that they be so adjusted to give the maximum gain without excessive tube noise. We have seen many supers in which no provision was made for adjusting the audio gain and most of these sets had at least a 56—more generally a 2A5 in the output stage. It is really surprising how the noise will drop if the audio stage is controlled. Many a set which at the present time sounds like a boiler factory will give good performance with this minor change.

With two good, high gain IF stages ahead of the second detector, there is no possible reason for making this latter stage anything other than a triode. Screen grid tubes are unnecessary and add a lot of complications in the form of feedback due to their greater sensitivity. Going to extremes, diode detection would be preferable from the standpoint of power handling ability, decreased tube noise and tendency to oscillate.

There can be no question but that the BFO is a most prolific source of noise in any super. Turning off the BFO usually results in a drop in noise of nearly 50 per cent. Controversy has raged far and wide over the reason for this additional noise, with the real reasons still remaining hidden. There are still certain precautions that can be taken to keep this noise down to a minimum. Push-pull detection offers a theoretical cure, but adds so many complications of its own that this method does not give the practical result which theory predicts. Some commercial receivers employ push-pull second detectors for the very purpose of noise suppression.

In general, the BFO must be COMPLETELY shielded from all other stages in the receiver. The only oscillator voltage that gets into the second detector must be via the coupling line. Isolating resistors and ample by-passing in the oscillator power supply leads are very necessary if this stage is powered from the same supply as the other stages. Bottom shielding is certainly not an unnecessary refinement.

Coupling into the plate circuit of the detector is perhaps the best method of providing an audible beat note. The common system similar to the Heising modulation scheme is very satisfactory, though it occurs that we might forego our prejudice against pentodes as second detectors if some workable system could be devised to couple into the suppressor grid while still maintaining this grid at ground potential. It can be done, but is not at all simple and requires the use of an additional coupling coil coupled to the oscillator with the hot end going to the suppressor grid and the bottom end grounded.

We cannot leave the second detector without one very important caution; the cathode bias resistor in this stage should be variable. Here, as in the first detector, maximum signal and minimum noise can only be achieved with the proper adjustment of this bias resistor. The ordinary fixed resistors available are not accurate and no reliance should be placed upon them to act as a bias resistor

in a stage where accuracy means operating on the proper portion of the characteristic. This resistor, once set, need not be touched and so it does not add an additional control.

The selection of the intermediate frequency to be used depends a great deal upon the effectiveness of the pre-selection (RF) stage in the high frequency portion of the receiver. Without proper pre-selection, the use of low IF frequencies is practically an impossibility. Image (a signal separated from the desired signal by twice the IF frequency), is apt to be very bad, particularly on the high frequencies. All this means that 175 KC, while affording a very substantial increase in gain over the higher frequencies, is "out" if poor or no pre-selection at all is used.

There is another very definite reason in favor of the use of a low IF frequency. It can be shown that the selectivity of a super is approximately 1% of the IF frequency. For example, by using a 500 KC IF we could obtain clean reception from two stations separated 6 KC apart. A 1000 KC IF frequency would give us a 1% or 10 KC width or, in other words, the two stations separated 6 KC's would now interfere with each other.

Mr. Sargent, in his new super, shows us how we may use a high IF frequency for image freedom and a lower IF frequency for gain and selectivity. This is a double super affair and is not at all complicated, requiring only an additional detector and oscillator. Conceivably, the 2A7 could be used in the dual role of detector and oscillator. The main disadvantage to this double super is the fact that unless good shielding is used throughout, the operator is very apt to be annoyed by little "peeps" on all bands, due to the harmonics from the oscillators. It must be stated in justice to Mr. Sargent that his super is free from this trouble, due to correct design and shielding.

With a means at our disposal for clearing our super of image, and at the same time the ability to use a very low IF, it is interesting to speculate upon the possibilities of carrying this to extremes.

There is no doubt but that a properly designed IF stage, as the second stage in a double super, could be made to work at very low frequencies, possibly in the order of 30 KC. Assuming that we used an air core and a low resistance winding we would have a coil of extremely high Q. Recalling what was said about the admittance band being a function of the IF frequency (1%), we can readily see that in the above case the band width would be 1% of 30 KC or .3 KC, which means 300 cycles. Not so far off from Quartz crystal performance. Here we are confronted with some obstacles that make this picture somewhat less glamorous. An inductance having as low a resistance and as high a Q as this one has, would need to be extremely well shielded to avoid oscillation. It should be remembered that oscillation can occur with only the very slightest provocation. When one considers the large physical size of the coil it is easy to imagine that complete shielding is no simple matter. Assuming that such shielding is possible, it can be readily imagined that one IF stage such as this, would, in all probability, give more gain than two stages at the common frequencies. In any case, the matter has so many latent possibilities that no discussion of IF amplifiers would be complete without at least a mention of the idea. We have hopes of being able to present some factual data on such a stage in the very near future.



I-T-K Radio Fraternity News

THE AMATEUR'S LEGION OF HONOR

This department is edited by the Hi-Kilowatt of the ITK Radio Fraternity, J. Richard Meloan (Jo) radio W6CGM-W6ZZGM KERN, 1302 "M" St., Bakersfield, California.

All communications concerning the I-TAPPA-KEE RADIO FRATERNITY, as well as inquiries from any amateur as to the Requirements for Membership, should be addressed to I-TAPPA-KEE HEADQUARTERS, either to the Secretary-Treasurer, Kenneth M. Isbell, W6AMR-W6BOQ, 5143 So. 6th Ave., Los Angeles, or to The Hi-Kilowatt, J. R. Meloan, W6CGM-W6ZZGM, 1911 Forest St., Bakersfield, California.

LAST MINUTE FLASH. By a vote of its membership the I Tappa Kee Radio Fraternity has changed its official name to "THE INTERNATIONAL RADIO FRATERNITY" in order that the name may better signify the international character of the organization as well as the fact that it engages in ALL phases of amateur radio and because its membership is composed of the recognized leaders of each branch of amateur activity. It is quite possible that the ITK initials will be retained to represent a degree, section or unit of the International Radio Fraternity and in that event it is probable that the initials will mean Iota Tau Kappa which we still have authority to use. All references to ITK in this month's department (too late to rectify) refer instead to the new name "The International Radio Fraternity". By the same token the title of "Hi-Kilowatt" is changed to "President".

New Members

WE extend a welcome to these new brothers who have just been admitted to our fraternity: W6FS, W8RN, W6GIS, W6AOJ, W6AN, W9INM, W6DXL, W2AQQ, W6HAG, W6SN, G2II, W8HYZ, W6CUU, W7AHQ, W6DYQ, W1SK, W6GBN, W6DPJ, W6CIS, W6ALU-CDU, W6GMV, W7BHH, W8HPC, W6CXW, W2BJ, W1CRA, W1CNU, W9CDE, W2EEN, W1AII, W6HOG, W3QP, NY2AB, W2TO, W4AG, W6EC, W4AA, K7ASM, W4OA, W1FIO.

W6DPJ "Cut" Miller of Provo, Utah, one of the AARS finest operators and most important stations says, "This ITK business—very fb! Many thanks for invitation. Am sending in application. It reached me while I was up in Wyoming helping W7DKW (ex W1ZZA-BIK; BX of Mexico, etc.), finish his log house and install PP '52 ham set. ITK surely seems to be a real organization. Hope I am accepted." (Ed. Note . . . He was and a good man he is).

S. G. Culver, W6AN, popular ARRL Pac. Division Director, writes: "Thanks for your very friendly letter. I assure you I appreciate it and also the invitation to place my application for membership in your organization." (We are glad to welcome W6AN as an ITK brother).

Traffic Department

CHIEF of Communications W6ETJ with Assistant Chief W6CH announce with pardonable pride as an ITK Official Trunk Line what is publicly acknowledged the fastest and most reliable multi-hop traffic circuit in the United States. This channel has been in operation for some time and repeatedly proven its worth and now that its member stations are ITK brothers we accept this as a major part of our international network.

Beginning with W1FIO at Norwalk, Conn., on the East Coast of the U. S. the first hop is to W9KG at Kansas City, Kansas, thence to W9ESA, Denver, Colo., to the West Coast to the hot spot of W6BMC, W6ETJ, W6EFK, W6ETL at which point the traffic that is trans-Pacific is distributed through various Oriental Trunks to KA1HR, AC2RT, K6EWQ and others. Traffic moves over the entire length of this circuit in one day or less! This is typical ITK traffic operation, only skilled operators are accepted into the fraternity. The above Transcontinental-Transpacific major trunk line branches into other ITK national trunk lines clearing radio messages in short order. These men hold as ridiculous the usual two to seven-day amateur radiogram service for they put their traffic around the world often in one day!

W6ETL, Fred L. Borch of Los Angeles, our ace traffic man, has among other skeds daily contacts with WLM, OM1TB, KA1NA, K6EWQ, and ITK trunk connections.

W1CRA, Sidney Carter, East Coast terminal on the International Traffic Trunk Line to W6CH thence to AC2RT: has his station at West New-



The YF of an ITK . . . W7COX, herself the owner of a modern amateur station, shown in the photo above. W7COX in the YL at the left, her sister is the party of the second part.

ton, Mass., where he is operating a rig consisting of 59-46-210-242A on normal frequencies of 7078, 3539, 3645, and 14156 KC. 7-9:15 a.m., 5-6 p.m., and other convenient times. Because of college work and leading the Howard Old Gold Coast Orchestra taking much of his time he has lately only been able to handle a paltry 500 messages a month! We wonder where that score would go if he had a few more hours to spare (?) A goodly percentage of those are deliveries, too. For a portable he has a Wing 5 meter Transceiver, likes to experiment with antennas, has a Baird Lab. Receiver, is a member of the E. Mass. Amateur Radio Association and at the present in spare time is engaged in building a transmitter for a crippled fellow who attends Harvard. Brother Sidney Carter . . . "A regular fellow and a crack operator"!

ITK Official Traffic Frequency is 3645-7290 KC. Any ITK station with a rock on that frequency can connect into a regular trunk line and clear his traffic bound for any destination in the world and rest assured that his message will be handled over the ITK network with speed, reliability and accuracy.

W6ETL again leads the ARRL in traffic totals for the month. Getting to be a habit, eh, Fred?

AFFILIATION: The ITK Radio Fraternity does not desire affiliation with any other organization. This statement is made in order to correct a false impression recently created by a mistake. ITK is an international fraternity quite complete within itself and therefore independent and able to stand on its own feet. Also it is officially chartered by Iota Tau Kappa as the Amateur Division. We prefer to maintain our identity. However, we extend cooperation to any recognized radio society in any cause for the betterment of amateur radio.

RSGB-ITK Cooperation

COINCIDENT with the acceptance into ITK of G2II, our first British member, is a letter received from Jack Clarricoats, Secretary of the Radio Society of Great Britain inquiring as to the possibilities of extending the ITK plan to all of Europe. This we shall be glad to do inasmuch as ITK is truly international in character and we find the RSGB a most worthy society. In accordance with the above plans are being formed so that full cooperation with RSGB may be effected so that an ITK European headquarters may be established through them.

G2II, David S. Mitchell of N. Wales, British Isles, writes: "I am greatly honored to think that I should be introduced to your society . . . Last year I was appointed County Representative of the RSGB and am a member of the RCC (European Ragchewing Club which is composed of many of the best operators of Europe) and was the fourth British station in their accuracy relay contest of last October. G2II is nearly always active on 1.75, 7, 14, 28 and 56 MC bands. I am sure your fraternity would be of interest to other European amateurs, and if you have no European representative I should be only too pleased to take that position, if you so wish, and would do my best to further the interests of the Fraternity in England, and other European countries." Fb G2II. Brother Mitchell jointly owns G2II in conjunction with Mr. A. M. Ralli and now has schedules with ITK members in the United States.

ITK PHONE

W6CEH, Brother Wilder, "The Down-trodden Farmer" of Santa Cruz, Calif., writes: "I appreciate greatly the honor I have received by being accepted a member of the

Amateur's Legion of Honor . . . Hope you fellows do not stress CW too much as I am pretty well along in years and amateur phone is everything to me, although I can copy twenty per if it is a decent first. To tell you the truth, I never got much out of CW, but Phone! that is something else again.

"I have kept the tube and parts makers eating regularly for the past few years. Just finished (if a rig is ever finished) a new phone rig, 300 watts and am getting good reports. I have been licensed for the past six years and always try to operate with consideration for the other fellow. I have been on the air over 2000 hours in the past two years and enjoyed every hour. I trust I shall always conduct myself in keeping with the high standards of ITK". Thanks, Brother Wilder. As previously stated this fraternity is actively engaged in all phases of amateur radio and we have some fb phone men who are not at all strange to a key. Some good stunts and contests are being worked out for these phone men and will be announced in the near future. W6CEH is an Official ITK Broadcast Station and disseminated the weekly and special Headquarters dispatches with his friendly voice.

Among the New Brothers

WHAT kind of fellows do we have in our fraternity? This is a question that often comes to the mind of outsiders. Of similar interest among ITK members in news concerning the new members of the past month. What kind of fellows are these, our new brothers? Let us answer both queries at once with some pertinent facts concerning some of the new additions to the membership roll. Space won't permit publication of the dope on the hundred or so new men who have been accepted by us in the past thirty days (dating back from March 10th) but here's some typical "Brief biographies":

W6SN, W. A. Lippman Jr., of Beverly Hills, Calif. Bill started back in 1921 as 9AQB of St. Louis with a 2KW sync spark. 1925 co-holder of call 9CVO operating 1000 watt CW. In 1927 was 9FAQ, moved to Los Angeles in 1930 and became W6SN. In 1932 supervised construction and operation of W6USA at Olympic Village, world famous amateur station which handled over 5000 messages in 60 24-hour days. As 9AQB Lippman was one of few midwestern spark stations to work sixth district. As 9CVO was first station east of Pacific Coast to be heard in China—also maintained nightly schedule with G6BY on 80 meters for 6 months when Eastern stations were having great difficulty in getting across the "pond". Also handled press on sked with WNP during two expeditions to the North Pole. W6SN uses at present a 204A with 800 watts input alternating with an 852 at 1/2 KW input. Normal operating freq.—7005 KC.

W6HOG, Frank Allen, Glendale, Calif., using an 852 in final with 1/2 KW input working on 7095, 7190, 14380 KC with a Comet Pro receiver started in radio in late 1920 with spark at Boone, Iowa, was first station there to try CW with three 202's in parallel. On at 9AOH and under call 9DCF until 1924. Moved to California—worked for L. A. Times and around KHJ four years. Became W6DRC in 1930 now W6HOG. Frank Allen has done considerable experimental work at W6HOG and for T.W.A. Worked all continents except Africa. Member of Glendale Radio Club, Delta Sigma Phi—USC, is married, age 30 and a six-footer.

(Continued on page 29)

42 A-Prime Modulator and Driver

By I. A. MITCHELL

Chief Engineer, United Transformer Corp.

THE writer's article on voltage amplifiers in the March issue of "RADIO" elicited a number of requests for an extension of the DB method of reasoning to normal class B and A (A Prime) power stages. On the whole, the method of calculating in the overall gain of a class B stage is somewhat difficult; however the chart illustrated in Fig. 1 gives a number of typical combinations giving all values. As tubes of different manufacture vary and operating conditions (voltage regulation, bias supply, etc.), are often different, actual practical values of audio power output are shown under average conditions.

Examining the chart, it is seen that the columns are reversed as compared to normal practice. This is only logical, as generally when designing a piece of apparatus we first consider what we want to get out, and then what we need to use to obtain the output. Columns 1, 2, and 3 indicate the values for typical class C RF. Column 4 indicates the effective secondary impedance required on the class B output transformer. Columns 6 and 7 indicate the audio output in watts and DB. Columns 8, 9, and 10 indicate the audio output tubes and their operating conditions. Column 11 shows the impedance which the output transformer primary should reflect to the tubes. The driver tubes are indicated in column 14.

It will be noticed that particular transformers and their corresponding type numbers are shown in addition to the other data on both input and output transformers. This is due to the fact that turns ratio is not the sole criterion of energy transfer. Resistive and reactive losses in both input and output transformers operate collectively in such a

manner that to design a transformer without actual operating data would lead to very poor efficiency and quality. The substitution of properly designed transformers for others of identical turns ratio in a class B amplifier, under the writer's observation recently, doubled the power output.

Column 15 indicates the DB level input required at maximum power output. If this value is subtracted from the amplifier output level in DB, the overall amplifier gain is obtained.

Using this chart as a base, let us examine a typical case. The lately released 800's and an A combination of 42's is interesting. Fig. 2 illustrates the general detail of a circuit of this type. Comparing the use of 42's against 2A3's for the driver, it is found that there is a great difference in tube cost favoring the 42. Using a pair of these tubes triod connected with 350 volts on the plates and 38 volts fixed bias a power output of 18 watts is obtainable. While a driver tube having considerable power handling ability is required to drive the 42's A, there is still an equivalent of 15 DB additional gain in the combination of three 42's against a pair of 2A3's which easily warrants the use of the additional tube. Using the method of determining required amplifier gain outlined in the March

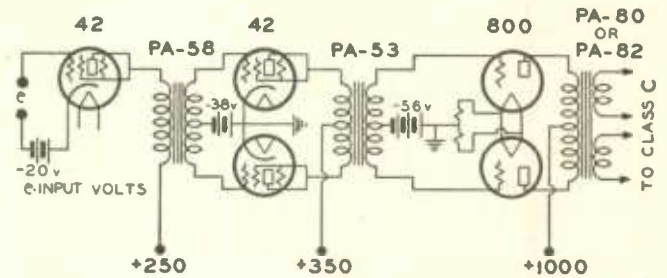

FIG. 2(A)

800 TUBE

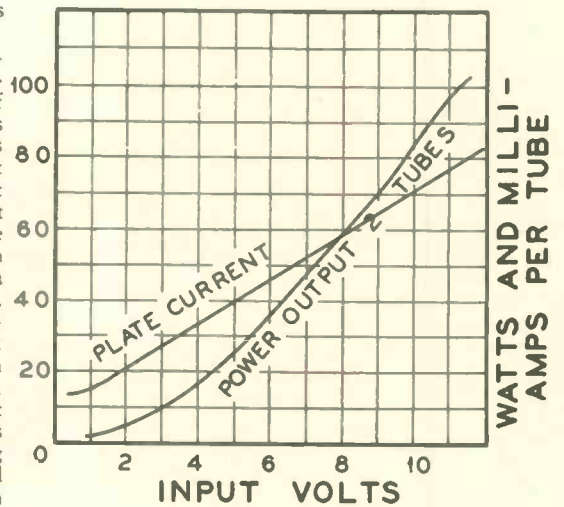

FIG. 2(B)

FIG. 1

RF				CLASS B							DRIVER			
1	2	3	4	5	6	7	8	9	10	11	12	13	14	15
RF Tubes	Plate Volts	Plate Current	RF Load Impedance W=Ohms	Coupling Transformer Type No.	Audio Output Watts	Audio Output DB	Class B Output Tubes	Plate Volts	Bias Volts	Class B Plate to Plate Load W=Ohms	Input Transformer Type No.	Turns Ratio Input Trans. Total Primary to 1/2 secondary	Driver Tube	Level into Driver DB
203A, 211E, 242A	1,000	400MA	2,500W	PA-60 or PA-62	225	46	203A's	1,000	38	6,000W	PA-54	3.2:1	2A3's	+8
852's, 860's	2,000	200MA	10,000W	PA-62	225	46	203's	1,000	38	6,000W	PA-54	3.2:	2A3's	+8
203A	1,000	400MA	2,500W	PA-62	180	45	830B's	1,000	33	10,000W	PA-57	2:1	2A3's	+7
852	2,000	100MA	20,000W	PA-82	100	42	800's	1,000	55	12,500W	PA-57	2:1	2A3's	+7
800's, RK-18's														
Single 203A, 211, 242A	1,000	200MA	5,000W	PA-82	140	43	242A's	1,000	60	8,000W	PA-53	2.5:1	42's A Prime	-6
Single 203A, 211, 242A	1,000	200MA	5,000W	PA-82	100	42	211E's	1,000	100	8,000W	PA-53	2.5:1	42's A Prime	-6
Single 203A, 211, 242A	1,000	200MA	5,000W	PA-80 or PA-82	100	42	800's	1,000	55	12,500W	PA-53	2.5:1	42's A Prime	-7
210's, 830's single														
203A, 211	630	140MA	4,500W	PA-83	50	39	210's	600	66	8,000W	PA-53	2.5:1	42's A Prime	-7
210's, 830's	500	110MA	4,500W	PA-83	30	37	210's	500	52	8,000W	PA-53	2.5:1	45's	0
46's	400	115MA	3,500W	PA-20	23	36	46's 59's	400	0	6,000W	PA-51	3:1	Single 59	-3
210's	450	130MA	3,500W	PA-20	23	36	46's 59's	400	0	6,000W	PA-51	3:1	Single 59	-3
Single 800, 825	800	57MA	14,000W	PA-71	23	36	46's 59's	400	0	6,000W	PA-51	3:1	Single 59	-3
46's	350	100	3,500W	PA-70	18	35	42's A Prime	350	35	8,000W	PA-58	1.6:1	Single 42	-7

REVIEW / D of Factory Receivers

The "Uni-Shielded Short-Wave Three"

IN SPITE of the development of large, super-sensitive receivers like the superheterodyne, many people want small, simple sets that are easy to construct, simple to tune and economical to operate.

While the "Uni-Shielded Short-Wave Three" has been designed especially for the short-wave novice, it is really capable of satisfying the discriminating short-wave fan. Its features are high RF sensitivity, simplified circuit and mechanical design, smooth regeneration control, ease of tuning, use of low-current drain two-volt tubes, specially designed short-wave coils, antenna tuning control, all-pentode operation, unusually thorough by-passing, newly developed self-shielded chassis design, and, last but not least, low cost.

The Circuit

THE circuit consists of a stage of RF, using a type 34 pentode V1, a regenerative detector also using a 34 pentode V2, and a single audio stage using a 33 pentode power output tube, V3. Since these three pentodes are all two-volt filament tubes, the A supply of this receiver may be two ordinary bell-ringing type 1½-volt dry cells, an Air Cell A battery, or one cell of a 6-volt storage battery, or any standard storage battery. Of course, the correct voltage reducing resistor will have to be used with each particular type of A supply to bring the voltage down to the required 2-volt value. For example, a 7 ohm resistor will have to be used in series with an Air Cell battery or with a single cell of a storage battery, a 3 ohm resistor will be needed in series if two 1½-volt dry cells are used, etc. The total filament current is only .38 ampere and this drain is so light that even the 1½-volt dry cells should last a long time without requiring replacement. Three 45-volt B batteries are required and 13½ volts of C battery. Only .02 ampere is drawn from the B batteries, hence this set is extremely economical in operation.

The Trimmer Condenser C1

ANALYZING the circuit, the first feature to attract attention is the trimmer condenser C1. This permits adjustment for various length aerials so that the set will work just as well on a long aerial as on a short one. The antenna tuning condenser also provides an extra adjustment when tuning in weak, distant stations, although it is not ordinarily used for this purpose. It will be noted that the antenna is connected through C1, directly to the RF tube V1. That is to say, the signal is impressed directly upon the grid of V1, dispensing with the antenna coil or coupler.

Tuning is accomplished by means of a .00014 mf. variable condenser C6 shunted across a plate impedance coil L1. The latter constitutes the longer winding G of a special four prong, plug-in coil. The shorter winding of this coil, T, serves as a tickler, being connected in series with the plate of the detector tube V2. The regenerative action thus obtained is very strong.

Regeneration is controlled in conventional (that is, for screen-grid tubes) manner, by varying the

screen-grid voltage of the detector. The potentiometer R4 is used for this purpose. This method of control is smooth and effective.

The short-wave plug-in coil is of special design. Four of these coils are used to cover the band from 15 to 200 meters (20,000 to 1500 KC). A feature of the coils is the band spread effect attained through proper design and the use of shielding.

Values of .0001 mf. for the grid condenser C7 and 10 megohms for the grid leak R3 have been found to give best results. However, in some cases it may be desirable to use a smaller grid leak such as a 5 or even 3 megohms.

The 2½ mh. RF choke, L2, serves to block off RF currents from the audio circuit. These currents are by-passed through the .00025 mf. mica condenser C8. Values both of the RF choke and of the by-pass condenser have been calculated care-

The conventional .01 mf. coupling condenser, C10, is employed between the detector and the audio stage. The 33 output tube has an undistorted power output of 700 milliwatts. This tube is capable of producing considerably greater power output than three electrode power amplifiers of the same current drain. Furthermore, the 33 has greater amplification than is possible in a three-electrode amplifier, without serious sacrifice in power output. The power handling ability of the 33 tube is made possible by the addition of both a suppressor and a screen between the grid and plate. The suppressor is placed next to the plate and is connected inside the tube to the filament.

The .001 mf. condenser C11 improves tone quality since it by-passes certain of the harsh or scratchy higher audio frequencies which are often especially noticeable with pentode output tubes. The triple spring open circuit jack J1 permits earphones or loudspeaker to be plugged into the output circuit as desired. When the plug is inserted in the jack, this also automatically closes a second circuit between B minus and the chassis. The jack is insulated from the chassis.

Unique Chassis Design

THE Uni-Shielded Short-Wave Three derives its name from its unique chassis design. The chassis, panel, and shielding are in one piece, as shown in the photographs. In effect, this results in a sloping panel of pleasing appearance, a "U" shaped shielded well for the three tubes and the plug-in coil and also effective shielding for the parts beneath the chassis. This design dispenses with extra shielding and, moreover, is efficient, rugged, compact, and economical. The chassis will readily slide into a metal or wood carrying case and presents a neat, attractive appearance.

While the Uni-Shielded Three has sufficient power to operate a loudspeaker on many stations, it was purposely designed to have high RF sensitivity so as to bring in the hard-to-get foreign stations on earphones. In other words, instead of increasing expense and complicating the circuit by the addition of audio stages, the designer concentrated on producing a simplified circuit, actually capable of bringing in extreme DX with sufficient power to be heard readily on a good pair of earphones. With the ordinary three-tube short-wave receiver, this condition is generally reversed, as most such receivers are designed with a "showy" audio system, but with a relatively weak RF circuit which falls down badly when it comes to bringing-in real distance.

The Uni-Shielded Three is easy to operate, since it is perfectly stabilized and more than amply by-passed. Naturally a certain amount of skill and experience is needed to bring in low-power for-

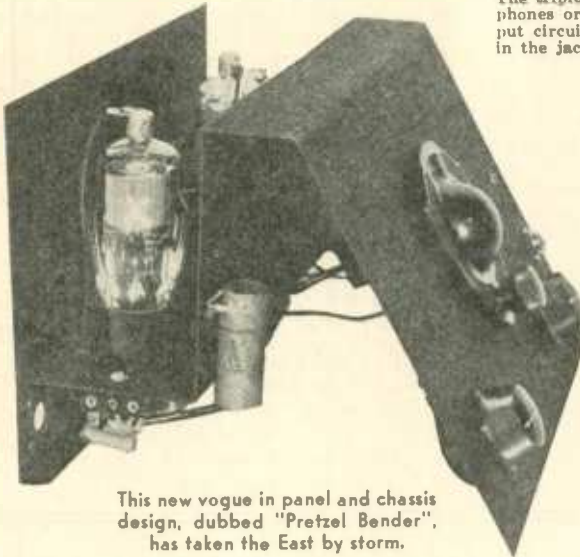

This new vogue in panel and chassis design, dubbed "Pretzel Bender", has taken the East by storm.

fully for high frequency reception and should be adhered to for best results.

The use of an audio plate choke at L3 adds immensely to the efficiency of the Uni-Shielded Three, permitting a higher plate voltage on the detector and thus increasing the sensitivity to an amazing extent.

Since the output amplifier pentode V3, uses a C battery for negative grid bias, a grid resistor R7, having a value of 500,000 ohms is used.

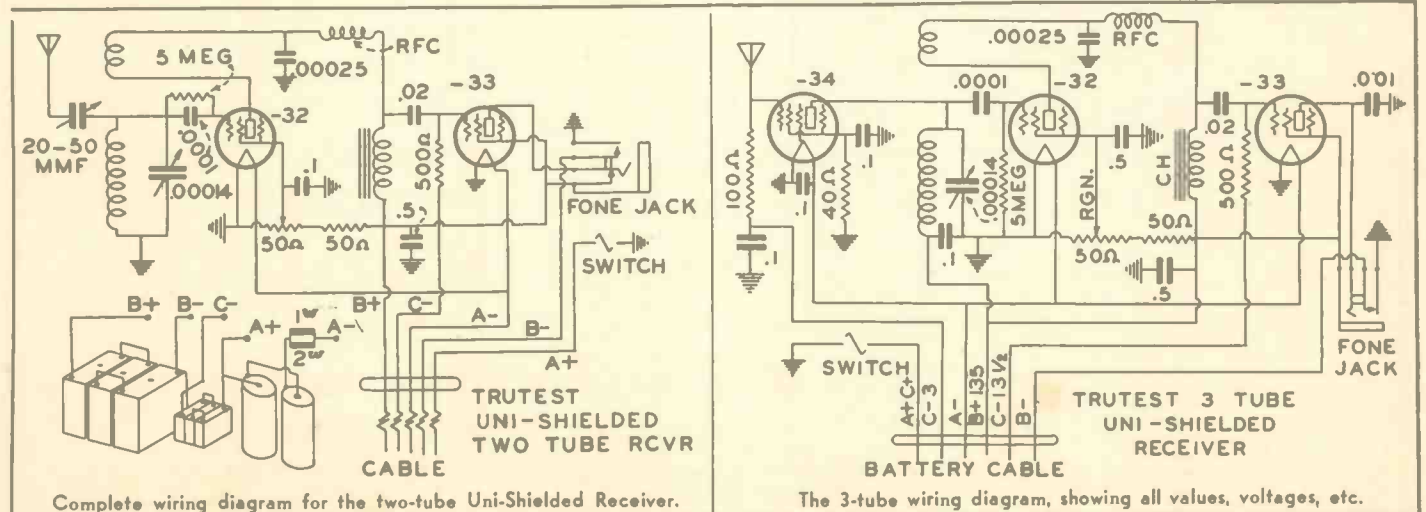

eign stations but there is nothing tricky about the tuning or the control of regeneration.

In constructing the receiver, the four sockets are mounted first. Then the jack J1, plate choke L3, tuning condenser C6, and switch SW1 are mounted on the front panel. As mentioned above, the jack must be insulated from the panel by fiber washers. The twin binding posts BP1, BP2, and the antenna tuning condenser C1 are mounted on the rear panel. Adjustment of C1 is made from the rear of the set.

The RF choke L2 is fastened beneath the chassis between the sockets provided for L1 and V2. The other small parts, which include carbon resistors and mica and cartridge condensers, are soldered in place while the set is being wired. In proceeding with the wiring, the grid circuits should be wired first, then the plates, next the filaments and finally the various by-pass condensers. The positive filament terminals of the tube sockets may be

LIST OF PARTS

NOTE: All C, R, L and V values are shown on the diagrams and are not indicated by symbols.

- C1—0-30 mmf. antenna condenser, Trutest
- C2—.1 mf., 400 volt Trutest Cartridge Condenser
- C3—.1 mf., 200 volt Trutest Cartridge Condenser
- C4—.1 mf., 400 volt Trutest Cartridge Condenser
- C5—.25 mf., 400 volt Trutest Cartridge Condenser
- C6—.00014 mmf. Trutest Variable Condenser
- C7—.0001 mf. Aerovox Mica Condenser
- C8—.00025 mf. Aerovox Mica Condenser
- C9—.1 mf. 400 volt Trutest Cartridge Condenser
- C10—.01 mf., 200 volt Trutest Cartridge Condenser
- C11—.001 mf. Aerovox Mica Condenser
- R1—100,000 ohm ¼ watt Trutest Carbon Resistor
- R2—40,000 ohm ½ watt Trutest Carbon Resistor
- R3—10 megohm 1 watt Trutest Carbon Resistor
- R4—50,000 ohm "EIF" potentiometer
- R5—50,000 ohm ½ watt, Trutest Carbon Resistor
- R6—50,000 ohm ½ watt, Trutest Carbon Resistor
- R7—500,000 ohm ¼ Trutest Carbon Resistor
- J1—Carter 103 Open Circuit Three Spring Jack
- BP1, BP2—Eby Twin Binding Post, Ant. & gnd.
- L1—Special Short-Wave 4-prong Shielded Trutest Plug-in Coil, wound on Bakelite form 1¼-in. diam.
- L2—1½ Millihenry Trutest RF Choke
- L3—200 henry Plate Choke
- V1—2 volt Pentode Type 34
- V2—2 volt Pentode Typo 34
- V3—2 volt Pentode Type 33
- SW1—G.E. Rotary Switch with Bakelite Knob
- 1—Bakelite Knob for Potentiometer R4
- 1—Kurtz Kasch Vernier Dial
- 1—Six Conductor Battery Cable
- 1—Roll Corwico Braidlite Solid Core Hook-up Wire
- 2—Screen-grid Clips
- 1—Trutest 5-prong Wafer Socket
- 3—Trutest 4-prong Wafer Sockets
- 1—Phone Plug
- 1—Pr. Frost DX Special Phones
- 3—45 volt B Batteries
- 3—4½ volt C Batteries
- 2—1½ volt A Cells or Eveready Air Cell A Battery
- 1—Special Metal Chassis

grounded directly to the chassis also the ground terminal BP2, the spring contact of jack J1, and the returns of the by-pass condensers. The A plus lead of the cable is also grounded to the chassis, as well as one end of the volume control potentiometer R4. The diagram shows the wiring to the bottoms of the tube sockets.

After the wiring is completed and checked, the cable should be connected to the batteries in preparation for the initial test. Tubes, earphones and one short-wave coil are plugged in and antenna and ground are connected. The coil covering the band up to 200 meters should be used for the first test. The regeneration control R4 is turned until the detector tube oscillates. Then a station whistle is tuned in. A slight adjustment of the antenna tuning condenser soon determines the condenser position for best reception, for the particular antenna being used. Turning back the regeneration control slightly to the point just before the set "spills over" clears up the whistle and brings in the desired station, loud and clear.

THE SKY-WAYS—AND RADIO

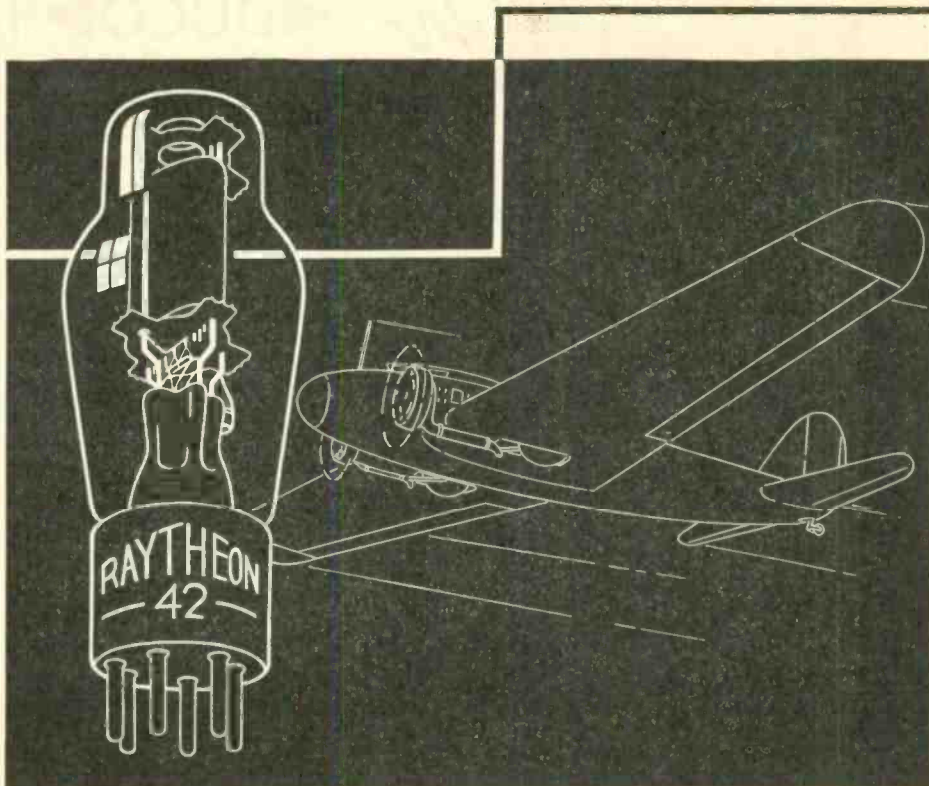

You have undoubtedly read of the importance of radio reception along the skyways. The country's greatest air-lines depend on it. For it is the traffic system of the air.

Weather reports . . . storm movements . . . these must be flashed to the pilot with utmost assurance of his receiving them clearly and distinctly. It is with good reason—the result of scientific investigation and long experience—that the majority of air-travel is made safe with Raytheon 4-pillar Tubes.

In the Raytheon laboratories at Newton, Massachusetts, the precision radio tubes to be used on these planes are assembled. Yet no special manufacture distinguishes them . . . no special department is devoted to their assembly and testing . . . no special tests are applied specifically to them.

They are the very same tubes used by police departments, by polar expeditions, in auto radios, and by millions of set owners all over the country.

For this reason, you can look upon Raytheon 4-pillar Radio Tubes with utmost confidence. They will perform clearly under the most rigorous circumstances, because their vital elements have secure, 4-pillar support—an exclusive Raytheon feature. Try them!



RAYTHEON 4-PILLAR RADIO TUBES

RAYTHEON PRODUCTION CORPORATION

30 East 42nd St., New York City
445 Lake Shore Drive, Chicago

55 Chapel St., Newton, Mass.
555 Howard St., San Francisco



DUCO

"Best by Test"

All DUCO Condensers fully guaranteed for one year.

In No Other Condensers Do You Find These Features:

1. Duco condensers are positively self-healing, even up to 3000 volts.
2. Better and longer life than the wet electrolytic condensers.
3. Smaller in size than any other make on the market.
4. For economy in costs it has no equal.
5. DUCO condensers in use over six years showing long shelf and use life.
6. All condensers are rated very conservatively.
7. Growing faster than any other make.
8. Used by best service men in the world.
9. Adopted by finest engineers of set manufacturers.
10. Guaranteed for one year.

DUCO CONDENSERS are fully protected by patents and patent applications all over the world. The response since we introduced our new condenser has been remarkable.

You, too, will be surprised at its performance.

Send for Free Catalog

Sales and Jobber Territory Open

Mfgd. by

Dumont Electric Co.

453R Broome Street

New York City, N. Y., U. S. A.

A New Slant On Antennas

(Continued from page 9)

purposes, much significant data was collected on the directional properties of these two antennas. Both antennas, since they ran in the same direction, were equally good broadside, i.e., to the South, and South Americans were worked with no particular trouble. Attempts were made to raise certain Japanese stations using the antenna directional to the East. These resulted in complete failure. The antenna facing West, and with the high end toward the East, was connected to the transmitter and our Japanese friend came back to us immediately with a report of R9.

Translated into decibels, or any other form you may care to use, the fact still remains that from zero to R9 is an infinite gain. Dozens of other stations proved beyond question of doubt the worth of this West antenna. Remember we mentioned that we had a hill of solid rock immediately to our West, standing right between us and Japan, and the top of this hill was at least a 45-degree angle from our antenna.

With these two antennas we were enabled to work in practically any direction which would have been impossible had only one of the antennas been used. The type of feed apparently makes very little difference! One antenna was a conventional Zepp, the other an end-fed Hertz. Undeniably, this latter antenna had some losses because the hot end of the antenna passed through the wall of the shack. In our case, with the power used this loss was apparently negligible. Some sort of a feed system would have been greatly preferable.

All of this sums itself down to one thing—that by adjusting the antenna for the proper degree of tilt a third direction can be added to a two-directional system. In this way the city dweller who must confine his antenna to a particular direction can, by this method, add a third direction to his already two-directional antenna. For example—suppose that a horizontal antenna had to be erected so that the ends were pointing East and West. As a half-wave antenna this antenna would be highly valuable North and South with very little radiation East and West. Excellent propagation can be obtained either to East or West by the proper tilt in either of these directions.

The proper angle of tilt can only be determined by experiment. It is indeed unfortunate that none of our present antenna systems are entirely uni-directional.

The nearest that one may come to this condition is to use an antenna several hundred feet long, which for most of us is out of the question.

•••

Trans-Pacific On 7 MC

(Continued from page 17)

The "number of QSO's" curve is of interest in that it is representative of 7 MC activity on the West Coast during a contest of this sort. The wide awake contestee will make a mental note of the big difference between the signal strength and activity curves from 0230 until 0530 and will plan accordingly for the next test. This is the time of greatest activity in this part of the world. The surprising lack of QSO's at this time is not due to any interference problem but to the fact that the West Coast contesters are sleeping at the wrong time of the day. Of course you must sleep sometime, even during a DX contest, but try setting your alarm clock at 0230 during the next test and notice the effect on your Asia and Oceania scores.

NEW! NEW! NEW!

Postal Two-Stage S. W. T. R. F. Preselector Unit. Self Powered

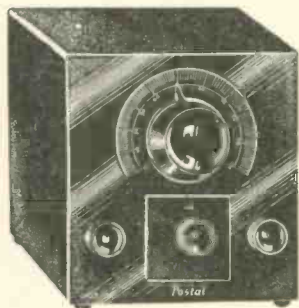

Something most every short wave fan and amateur has been waiting for. A short wave two stage T. R. F. Preselector and booster that can be used on any receiver regardless of the price you paid.

When connected to your receiver the Postal Booster will increase the sensitivity and selectivity over 300%. It is guaranteed to eliminate repeat spots, image frequencies and lower the background noise considerably. Hear stations that you could never hear before.

CONSTRUCTION

The Postal Booster employs two R. F. Pentodes (78) for the two R. F. stages and 1-25Z5 Voltage doubler for furnishing the "B" power. For convenience and efficiency the new two draw coils are used for wave changing. It can be connected in a minute, and operated independently of your receiver. Guaranteed for one full year.

A sturdy custom built laboratory instrument designed especially for the most critical Amateur and Short Wave Fan.

NET PRICES

The Postal Booster Laboratory constructed and mounted in a rugged crystal finish case and with one draw coil for any band..... \$19.95
 Matched set of tubes (2-78, 1-25Z5)..... 1.95
 Additional draw coil for any band or band spread..... 3.95

POSTAL RADIO CORP. 135 R LIBERTY ST. NEW YORK, N. Y.

MICROMETER FREQMETER

The latest in amateur frequency meters—it has a micrometer for a dial.

Amateurs over the country say "I can set and read frequencies 'on the nose' as never before."

The MFM is all a.c. operated, comes complete, ready to use, and is engineered to have a stability and permanence on a par with the precision of the micrometer.

—Technical data on request—

G. F. LAMPKIN LABORATORIES
 146 W. McMillan St. Cincinnati, Ohio

SMITH-PRECISION CRYSTALS

Full-sized, specially ground X cut crystals; powerful, accurately calibrated, single-frequency oscillators. Unconditionally guaranteed.

3500-4000 kc /s—Close to Frequency, \$2.35

7000-7500 kc /s—Close to Frequency, \$3.95

3500-4000 kc /s—To Exact Frequency, \$2.90

465-525 kc /s—S.S. Filters X Cut... \$2.60

Postpaid by airmail.

Commercial Frequencies at Attractive Prices.

W. W. SMITH W6BCX

Pioneer Manufacturer of
 Fine-Quality Piezo Plates

215 West Cook Santa Maria, Calif.

"SLIDE"

(Continued from page 5)

That was what made Al so useful when the bridge and wires went out at Chitina, and it was what impelled the foreman, scrambling down the dirty, gray mess of the slide, to shout and squint his eyes at the struggling pajama-clad figure below him—

"Hey—that you, Al? Goody, boy—gosh, are you hurt?"

"Naw", said Al, rolling over on all fours, free of the snow. "Ouch! Maybe I am, though. The right arm seems a bit weak."

"Here, get on my back, son. You've gotta get dried off. Also we need a wireless operator damned quick."

"Well, better bring that 'B' battery along, then", said Al, "and there's my key, by gosh. And get all the other stuff together."

The foreman picked up the battery and the key, shouldered Al like a sack of flour, and then directed the other men, who were fast arriving with picks and shovels.

"Get everybody out that's under, and bring 'em up to the camp as soon as possible. And keep your eyes peeled for that damned radio gear. Bring it all up, too."

+ + +

When Al's arm was bandaged he took the tunnel for Bonanza, accompanied by the "B" battery and his key. On the telephone there he got in touch with McGavock in Kennecott.

"I've got my bug and a good 'B' battery here. If they bring me the receiver we can key your transmitter over the telephone line and I'll use my own receiver here."

Luckily, the receiver was found and brought to Al, who repaired it hastily. In a very short time, K7BLI with Al Domenico at the key, waggling a very sore wrist but still putting out readable signals, went on the air. It seemed as if all the world were waiting for him, then.

No sooner had he called than his old friend Virgil Hanson, far across the Gulf of Alaska, answered with the familiar call of K7BND. Then Lily Osterback, that unflinching star of the radio firmament, standing by as K7ANQ on her lonely island. Then Richard Fox, K7PQ, in Ketchikan. And perhaps more than any others, those faithful stand-by stations for Alaska hamdom—W. E. Maunula in Chomly and John B. Waskey in Seattle—K7FF and W7TX. All were there, knowing that disaster had occurred, ready to speed the traffic which could go over one route only—through the bruised wrist of Al Domenico!

"... Lost a pair of sox in the excitement—otherwise all okay"—thus read one message, a reassurance to a wife's query from Seattle as to her husband's safety in Jumbo camp. For, when news of the slide became known, newspapers throughout the country screamed the disaster at anxious relatives of the Kennecott miners.

Some messages were not so cheerful, telling of the dead and the injured.

Still other messages dealt with the management of the mine—paid messages sent through commercial channels as far as those channels reached in the disaster of a Chinook wind, from whence they took flight by amateur radio—free of charge—and were delivered with a promptness and accuracy that defied comparison.

When the slide was cleared away and another bunkhouse was built, K7BLI was rebuilt and returned to the air with his former vigor, speeding the dots and dashes to his friends far and wide—on the Pacific coast, in Hawaii, in Guam, in China, in New Zealand and Australia, or on the undulating surface of the Pacific. The station stayed on the air until the depression shut down the Kennecott mines altogether.

When he comes back—or even if he never comes back—K7BLI will be remembered as one of the "stout fellas" of amateur radio.

ITK Radio Fraternity News

(Continued from page 24)

W3QP, Jack Morgan, in Philadelphia, is another 1 KW ITK brother of which there are many by reason of an xtmr with 47 xtal, 46s parallel, 3A, Collins network to antenna. Portable is Collins 4A. Receivers are Ross and RME-9. Operating frequencies 7288 and 7035 KC. Jack began his career as a brasspounder in 1919, licensed in 1923. Worked expeditions, ships, dx contests, and has a taste for dx skeds. A reliable schedule with YK6HG with 280 qso's to his credit bears evidence of this desire. This sked has been for the benefit of the Carnegie Institute, Department of Terrestrial Magnetism at Washington, D. C., to assist in their inter-observatory communication and reports. (By the time this is printed it is expected that YK6HG will be an ITK brother as will also W2CC who has had over 800 QSO's with him).

•••

NY2AB, Arnold Pincus, is our first brother at Cristobal, in the Canal Zone and is located at Emanates signals with a PP TPTG xtmr, 300 watts input on 7020, 7090, 14040 and 14180 KC. Skeds ITK brothers and handles important traffic. Graduated from advanced training course at Great Lakes Naval Radio School in 1920 serving at ship and shore naval radio stations for the next 8 years progressing to Chief Radioman. Present occupation with Electrical Division of Panama Canal. Operates NY2AB by reason of qualification as CRM—USN. Commercial ops will recognize Arnold as operator at NAX for 4 years. Pincus is 32, married and his hobbies other than radio are tennis and fishing.

•••

W4AG, of Kennedy, Alabama, and answering to the name of M. H. Gravlee, is a six-footer and then some—age 24. Is another ITK with an Extra First Amateur ticket by reason of which he operates a good transmitter consisting of 47, 46, 310, 261A with 300 watts input on 7020, 7050, 7090 KC usually. National FBXA receiver completes the set-up. Mixes ragchewing with DX and traffic. Attends ham conventions from Chicago to Birmingham and in his spare time works for a living in his father's general store listening to the quaint remarks of the cotton farmers as they reconstruct the government while W4AG is getting their meal, lard and flour not to mention a dime's worth of "chewin" ready to load on the "waggin". M. H. says, "I work quite a few W6's and will be pleased to meet on the air the ITK gang on the West Coast. Any time I can be of help let me know."

•••

W9GMV, Theodore L. Carnes, Minneapolis, Minn., now operating normally on 7010 and 7296 KC., has been maintaining regular skeds with NY1AA since Jan. 1, 1933, handling important traffic. Brother Carnes first took to the air with 9QW in 1914 at Indianapolis then became Radioman 1st Class USN, doing duty overseas, to Europe four trips, and at NPC, NUZ, NPZ, NVD, NPH (in charge 1921). Worked on the old KPC-KPB circuit, Astoria, Oregon, hi-power spark 2½ years handling all commercial traffic both Morse and radio. In 1922 went to sea on Matson Line. Previously at KGH in 1921 (extra op), 1923-24 leased wire and civilian operator at NPG Bureau of Markets, Graduated from University of Ariz. 1927 with B.S.E.E. (Communications). Came back to ham radio in 1931 with present call. Still hold First Class Commercial license and operates an active ITK amateur station. Brother Carnes' code speed is more than 45 wpm and no tellin' what he could do if he strained himself a little. Hi.

QUALITY

at a Price You Can Afford to Pay!



FRANKLIN Transformers

Very conservative ratings on Transformers and Chokes for every Amateur Station.
"MOST SOCK PER DOLLAR"

Write for Catalogs

FRANKLIN TRANSFORMER MFG. CO.

607-609 22 Ave. N.E., Minneapolis, Minn.

WIRES

AERIAL

BATTERY

HOOK-UP

IGNITION

LEAD-IN

MAGNET

MICROPHONE

PUSH-BACK

SHIELDED

Consolidated Products fulfill every Radio requirement for wire and cables. Consolidated standard of quality is rigidly maintained irrespective of price.

Consolidated Products are guaranteed as to length, weight, size and count as specified.

When buying wire or cables be sure to demand Consolidated—Carried in stock by the leading jobbers and dealers—and know that you are getting the best for your radio work.

CONSOLIDATED
WIRE AND
ASSOCIATED
CORPORATIONS

Peoria & Harrison Sts., Chicago, Ill.

NEW BOOKS!

"RADIO" can supply ANY Book . . . by any author. Send your Book orders to us. They will receive prompt attention



SHORT WAVE ACCESSORIES WITH A REPUTATION

We manufacture a complete line of S.W. equipment including coils, condensers, converters, crystal holders, chokes, transmitting sockets, S.W. and all-wave antenna systems, etc. The following are typical of ICA values.

ICA Shielded R.F. Choke
Finest shielded choke for S.W. use made. Available in 2½, 3½, 5½ and 10 M.H.
List price 75c
Also 30, 60, 80 M.H. \$1.00
List price

ICA No. 277 High Frequency Choke
Wound on Insulux form. Inductance 2½ M.H. Will carry 125 milliamps without heating. Distributing capacity 1 mmf. None better. List price 75c

ICA Bakelite Ribbed Coils
Wave lengths 16-217 meters. 4 prongs. \$3.00
List price
Same as above with 6 prongs, 3 windings. \$3.75
List price

Other ICA coils available in Ultra Low Wave lengths from 9-21 meters as well as regular broadcast band from 190-550 meters.

Trade Discount 16 Diagrams FREE
To dealer, servicemen and Hams, 40%. Your jobber or favorite M. O. House will give you information or write direct. together with brand new specialized s.w. catalog just off the press. Get your copy today!

INSULINE CORP. OF AMERICA
23-25 PARK PLACE, NEW YORK, N.Y.

Gentlemen:
 Send your FREE catalog together with 16 wiring diagrams.
 Send me name of nearest ICA jobber.
Name.....
Address.....
City.....State.....

DEPT. T-54

COMMERCIAL RADIO

20
CENTS

DO YOU KNOW?

What is going on in the Airway field of radio?
What the latest developments in the experimental labs. are?
What the latest equipment is in the big broadcast stations?
What the activities of the men behind the transmitters are?
The design of the larger Foreign transmitters?

The requirements for a Commercial Ticket; what The I. B. E. W. is; The news of The American Radio Telegraphists Association; The enterprises of the Veteran Wireles Operators, Ship News; Broadcast Station News; Advanced Technical articles; Police Transmitters.

If You Read "Commercial Radio" You Will Find All of This and More
A real professional radio operators magazine—the only one of the kind published in America. Subscription price \$2.00 a year. Published Monthly.

COMMERCIAL RADIO 112 West 13th St.
New York City

Something NEW Again in Condensers! The Concourse "Pee wee" Paper Tubulars

THEY MAY LOOK LIKE OTHER MAKES
but
HOW DIFFERENT IN CONSTRUCTION
and
HOW SUPERIOR

Smallest on the Market

In addition to our usual extensive line of DRY ELECTROLYTIC and WAX PAPER CONDENSERS,

We now have available a complete line of Dry Electrolytics for the A.C.-D.C. Radio Sets...



Capacities from .0001 to 1 mfd.
Voltages 200 - 400 - 600

• WE SUPPLY REPLACEMENTS FOR ALL POPULAR SETS

— Write For Our New Catalog —

CONCOURSE CONDENSER COMPANY

387-411 WALES AVE.

NEW YORK CITY, U. S. A.

TRIMM PHONES



designed to meet your specific requirements.

If the product you are designing or marketing requires a headphone, make sure it is one that will give the utmost in performance and service. TRIMM PHONES represent the highest in quality and efficiency because they are made for your individual need. We have a phone for every purpose. Our engineers will be glad to assist you.

TRIMM RADIO MFG. CO.
1528 Armitage Ave. Chicago, U. S. A.

LATEST IN "B" POWER



Smallest unit on the market. 2 7/8" wide, 4" high by 5" long. This complete Genemotor furnishes up to 200 volts D.C. Operates from 6 volt storage battery. Ideal for Auto, Airplane or Battery Radios, and Portable Amplifiers.

Write for details and prices on this and other types.

CARTER MOTOR CO.
365 W. Superior St. Chicago, Ill.

The A To Z Of Link Coupling

(Continued from page 7)

Some of the Commonly-Used Tube Combinations For Link-Coupled Amplifier Circuits



(a)—The simplest form of a link coupled transmitter uses a 47 (or 2A5) crystal oscillator and a 46 buffer or doubler. Two 46's can be used in parallel for greater output. The output of this combination ranges from 25 watts on 160 meters to more than 12 watts on 20 meters.



(b)—A two-band link-coupled arrangement using a 47 (or 2A5) oscillator, 46 buffer-doubler and a 210 in the final stage. Its output ranges from 20 to 40 watts, depending on the frequency used and the efficiency of the circuit.



(c)—A link-coupled arrangement for high efficiency and high output from small tubes. A 47 (or 2A5) crystal oscillator, 46 buffer-doubler, 210 buffer and a pair of 210's in the final amplifier running at high plate voltage. The output ranges from 75 to more than 150 watts.



(d)—Link coupled medium-power transmitter. A 47 (or 2A5) crystal oscillator, 46 buffer-doubler, and one of the new 40 watt tubes, such as the 800, 825, RK-18, O3A or 211. The output ranges from 50 to 150 watts and more.



(e)—An ideal combination for high power. Link coupling the 47 to an 865, doubler-buffer, to a 210 buffer to an 800 buffer and, finally, into an HK-354 Gammatron. 800 watts has been secured from the use of this combination.

COIL-TURNS TABLE

For Link-Coupled Stages

(For low and intermediate power stages)
1 1/2-in. Hammarlund Coil Forms.

80 Meters—36 turns No. 20 enameled wire, space wound.

40 Meters—20 turns of No. 16 or No. 18 enameled wire, space wound.

20 Meters—10 turns of No. 16 or No. 18 enameled wire, space wound.

.001 (100 mmf.) variable condensers are used to tune the above coils.

Coil-Turns Data For Higher-Power Stages

Use No. 12 enameled wire, space wound, on a 2-in. form. For 80 meters wind 32 turns; for 40 meters wind 16 turns; for 20 meters wind 8 turns. Use a .0001 (100 mmf.) condenser to tune these coils.

BIRNBACH All-Wave ANTENNA



Strong, clear signals and less noise on broadcast and short-waves. Kit includes doublet antenna, coupler, all wire and accessories. Complete, \$3.75. Write Dept. PR-4 for valuable radio data.

BIRNBACH RADIO CO., Inc.
145 Hudson Street, New York City

CRYSTALS 95c

In 80 or 160 meter band within 10 kilocycles of your specified frequency. Guaranteed oscillators.

Kleber Heavy Duty 866s. Guaranteed 1000 hours\$1.49
 866 filament transformers. 15,000 volt mica insulation\$2.25
 Front of panel sockets. UX or UY mirror finish aluminum\$.98
 Standard Relay Racks\$10.00
 TAYLOR carbon plate 203A, 211 and 845\$12.50
 TAYLOR 825. The original 40 watt, 55 watts in class G.....\$4.95
 Western Electric mikes rebuilt. Includes new diaphragm, new carbon and buttons redressed\$6.50

INCLUDE POSTAGE

We buy, sell and trade amateur apparatus of every description. Write for circulars

KLEBER RADIO LABS.
 Box 55, Belvidere, Ill.

FREE 1934 WHOLESALE RADIO CATALOG

Radio Replacement Parts, Sets, Tubes and Electrical Appliances at great savings
Wholesale Merchandisers, Inc.
 626 R, Broadway, New York City

it's New!

NO. 90 TEST SET



Here is the latest thing in a multi-purpose test instrument especially adapted for quick and accurate testing of amplifiers, radio receivers and other electronic apparatus—this S.E.C. No. 90 UNIVERSAL TESTER measures Potential A.C. and D.C. from 5 to 1000 volts—Current from 1 to 100 M.A.—and Resistance from 0.1 to 100,000 ohms. (Note the new low ohm range, reading accurately from 0.1 to 20 ohms directly on the

meter.) Also measures Inductance, Capacity and Impedance—and is completely self-contained. Unusually convenient and accurate.

This is one of a 3-unit set, any one of the 3 units (No. 90 UNIVERSAL TESTER, No. 91 Analyzer or No. 92 Electron Coupled Oscillator) can be purchased separately or together in a Carrying Case with Cable and Adapters. Buy the No. 90 TESTER now and others later or when the purchase is more convenient perhaps. Each unit can be used by itself, each will pay for itself independently and when you finally get all three you'll have a complete, guaranteed kit at a remarkably low total price. Professional equipment at low cost. Bulletin sent FREE describing all 3 units of this most useful Servicing Set. Use Coupon below.

SOUND ENGINEERING CORPORATION
 416 NORTH LEAVITT STREET CHICAGO, ILLINOIS

Send for more information

SOUND ENGINEERING CORP.,
 461 N. Leavitt St., Chicago, Ill.
 Send latest bulletin on S.E.C. Test Instruments.

Name
 Address



Scratchi Combs the Airwaves

By DAVE GIBBONS

Osockme, Japan,
 February 23, 1934.

To Editor Person of "RADIO", (which shuffle forth New Deal each month).
 Dear Sir Ed:—

When you ask me in letter few weeks aback to inform you of low-down opinion about program listening. I try to get to rocky bottom of entire business. So I consult at once with my Cousin Scratchi, (—"That's starting from scratch, eh! Graham!", as Ed Whinney might neigh on oily program).

In cases you do not know, Mr. Ed, my cousin Scratchi are very brain-trusty person who make slight living in the dot-and-dash business on many maru-boats for several years. He are sometimes (not too often) in pleasant frames of mind and conduct one-man polls on upstanding topic of the days. He then expel several conclusions which he arrive at and allow the dearly listener to take own choice.

So I clop along to one-room bugloo which my cousin infest when on beach, which are at present. I rap-rap on door and when I come-in-please he are busy lashing together 16 tube super mister-piece, which he are making for too-rich friend, and he explain at me that this are one fine method for distributing wealth of nation more flatly to all.

"How come so?" I dib.

"At present moment," he crack back wisely, "I have too much experience and too little money, but when bloaty plutocrat who are purchasing this monument of human skill gets through learning how to jiggle all the little knobby gadgets which you see here, I will have the money and he will have the experience."

"Mightbe he will have headache also?" I snick.
 "He will have enough headaches to supply full-size distillery", Scratchi whoop with toothsome smile.

"But will not splendid marvel set like this bring in programs from all earthly places?" I pose.

"Indeed yes!" he quote, "and that are mainly reason for severe pain in dome and elsewhere. This georgous go-and-getter radio set will bring in 16 times as many punkish programs as humble one-tuber, and since it makes them 16 times more louder, that makes it 32 times more maddening to listen at."

"But do not some very first-rate musickers appear nightly over microphones?" I quirk.

"Oh, truly indeed!" he respond. "Last night, for an instance, I listen at great violin expert who play very lovely classical piece, and before last note of sonata have died off, announcer snap in to ask in terribly earnest and refined tone of speech "How is your stomach?" Announcer then continue same thing in other words about 2 or four times and then start saying, "The great violinist will now play that beautiful . . ." but I am already on my way to another part of house, as announcers suggestions are much too powerful."

"What else did you pick-off last night?" I quest.
 "After I return to listening," Scratchi say, "I hear great orchestra playing favorite opuses, but right in middle the music are faded down low and announcer smoothly ask audients "Do you know the badness of roughish tissue paper?" Then for 10 or 8 minutes he describe what beautiful, silky, satinish tissue paper he are selling and he beg that everybody go quickly to telephone and order some of it from grocer person immediately, now-at-once. Since this sound like highly personal remark to me, I spin dial rapidly and fish for something more suitable for living room."
 "Did you pull in any snappy fish?" I require to know.

"Several ones," he response at me, "all smelt. First I catch the Bad Breath Hour, then the Filthy Feet Hour, next the Sour Stomach Hour, and after that the Awful Odor Hour. Each radio Hour, of course, are only 15 minutes really time, and consist mostly of 8 or ten minutes of advising and begging and pleading for listener to buy special remedy for every disease they say he have, even if he have not.

I escape from such ham medical advicers and hunt further off, and I catch the Wispy-Crispy Flakey-Cakey Hour on Purple network. I try the Ultra-Violet Chain and catch four coffee-peddling

programs. One announcer say his coffee have date on can, so they can take it back off grocer's shelf each week and put on new date. Other man say his coffee are so good it have no date on can so it can stay on grocer's shelf forever."

"Mightbe, perhaps", I venture out, "that radio programs are in need of new broom and new talents?"

"You said a bottle-full!" say Scratchi, "and that are reason why I are learning to play fancy guitar."

"What do such music-study mean?" I ask.

"It mean that I are collecting together very novel radio group which will make grand hit on ether quite soon. It are called the 'Original Japanese Hilly Billies' and we will come down from the mountains to studio with very funny dress-ups each night."

"Somebody pay you for such?" I amaze.

"Oh, yes!" Scratchi say, "our sponsor are going to be the 'Dainty Lady Pinky-Pantie Hour'. I have composed snappy march theme song for opening number. It are called the 'Pinkie Pantie Rag', and as special favor feature we will announce on each program the correct time of the month. Also as other special curtsy—"

But I have already slapped door shut from outside, and are going away in high gear, as I feel that are enough of that for one period.

Hoping you feel the same, Mr. Ed,

Yours hopefully,

Hashafisti Scratchi.

You'll Praise This New 10-WATTER

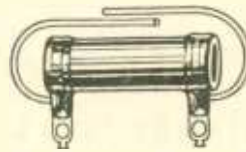

COMPACT, wirewound, vitreous-enameled—a low-priced, efficient, moisture-proof ten-watter that will be welcomed wherever quality with economy is a factor.

Positive, low-resistance contacts through non-oxidizing Monel metal bands and lugs—plus pigtailed for convenience. Will withstand high temperature, give long usage and permanent resistance value.

Same type made in three sizes, three ratings and 67 resistance values.

FREE Vest-Pocket Volume Control Guide



Write Dept. PR-4

For Complete New Catalog



FREE FORDSON CATALOG OF RADIO VALUES

Send for it today!

Any Set
30-Day
Trial

All models guaranteed; long and short wave; all-wave supers; AC-DC; battery; 6 and 32 volt; all electric car radio, etc. Month's trial FREE. See remarkable values in new catalog. Write today. Prices—\$9.45 UP

FORDSON RADIO MFG. CO.
DEPT. 4, 4185 OAKMAN BLVD., DETROIT, MICH.

LEARN RADIO CODE

Quickly and Easily at Home and become a Skilled Amateur or Commercial Radio Operator

CANDLER Training Will Enable You to Build and Operate Your Own Amateur Station, to Read and Send Code and to Obtain Your Government License. Complete Home Study Course trains you thoroughly and quickly. INEXPENSIVE. Write today for new BOOK OF FACTS explaining everything. No obligation.

CANDLER SYSTEM CO., Dept. D3
6343 So. Kedzie Ave., Chicago, Ill.



BRINGS A New THRILL to RADIO

Listen to FOREIGN STATIONS AIRPLANES SHIPS AT SEA



Here is 1934's Great Radio Sensation! This amazing short wave receiver has been acclaimed editorially by radio engineers, users and by leading radio magazines, including Short Wave Craft, N. Y. Sun, and Short Wave Radio Magazine. What a thrill it will bring you. Foreign stations, airplane calls, police calls, ships at sea... the entire world at your fingertips! Truly the greatest, most highly developed simplified, low priced short wave receiver yet developed. This set originated, developed and sold only by Wholesale Radio Service Co., the largest organization of its kind in the world. See coupon for prices.

SHORT WAVE HEADQUARTERS

We have everything in short wave equipment. Sets and kits from 2 to 6 tubes, coils, converters, condensers, chokes, crystals and holders, transmitting tubes and equipment. All nationally known lines including National Hammarlund, Lafayette, etc. Bring your short wave problems to us. We can help you!

BIG NEW FREE CATALOG

Over 10,000 items listed. Big Special Section on short wave. Anything and everything in radio. We have the world's largest stock of replacement parts and parts to assemble or build any kit or set described in all leading Radio Journals. Everything at lowest wholesale prices.



Wholesale Radio Service Co. Inc.
100 Sixth Ave., New York, N.Y.

Department P-44

I enclose \$..... for the following:
Unshielded "2" Kit of parts..... \$5.75
Unshielded completely wired add..... 2.50
Complete set of tubes..... 1.93
Set of 4 Special coils..... 1.45
Send me your new FREE catalog 55C.

Name.....
Address.....
City..... State.....

What Judge Sykes Says About the Treaty

(Continued from page 4)

tions. The Federal Radio Commission indicated its approval of this course of procedure in a letter to the Secretary of State, dated December 2, 1933.

JUDGE SYKES was chairman of the American delegation at Madrid. He is chairman of the Federal Radio Commission. He has always been much more than a mere commissioner. He was one of the two who, when there was before the Commission the most momentous subject on which that body was ever called to act, voted to uphold the clear wording and intent of the Radio Law. The other three commissioners refused to accept the position of Judge Sykes and General Salzman and voted that the law did not mean what it said. So when Judge Sykes makes his statement of the right of the amateurs to handle third-party messages internationally under the 1927 treaty, and his explanation of the effect of the change upon the amateurs made at Madrid, he blows to smithereens the assertions of Mr. Warner who was the chief representative of the ARRL at Madrid.

Warner has printed and written reams upon reams of stuff and broadcast it throughout the world—to amateurs and to the great number of commercial radio people who are members of the ARRL—in his effort to prove to the amateurs that their handling of third-party messages with a foreign country, (China, for example), has been "against the law" ever since 1927. Judge Sykes disposes of Warner's contention around which he has built all his stacks of propaganda.

WHEN Warner returned from Madrid with the new amateur restriction in his pocket he refrained from disclosing this restriction in his first report mailed to the directors of the ARRL. Later he refrained from disclosing it in his published report to the members. Still later he refrained from disclosing it in his annual report—dated April 1, 1933—to the Board of Directors. He refrained from disclosing it to the directors at their annual meeting the following month. Warner, instead, made two flat statements: One, "From a practical standpoint there is no change in our communications regulations". The other, "The Madrid convention takes effect the first of 1934 but we'll never know the difference, because it has no effect on us". Judge Sykes' letter conclusively disposes of these statements.

"RADIO" pointed out in its issue of September, 1933, that there was a wide difference between the 1927 amateur restrictions and those of Madrid. It pointed it out in subsequent issues and explained fully the practical effect of the difference. Warner asserted repeatedly—and keeps on asserting—that there is no essential difference. Judge Sykes now shows that there IS an essential difference and shows just what the essential difference is. And on page 4 of "RADIO" for November, 1933—a month before Judge Sykes' letter was written—you may find the difference described in almost the Judge's own words.

Clair Foster, W6HM.

SPECIAL GROUP SUBSCRIPTION RATES TO RADIO CLUBS

Generous discounts on subscriptions if 5 or more members subscribe at one time. Radio club secretaries are invited to write for special proposition. "RADIO", Pacific Bldg., San Francisco, Calif.

LEARN CODE AT HOME

Easy—Efficient—Quick



The Instructograph is the ideal method to correctly master the code. Complete outfit can be rented for as low as \$2.00 per month, and can be applied on purchase price if desired. Get started now and become a full fledged Ham. Write for interesting circular.

INSTRUCTOGRAPH CO.
914 Lakeside Place, Chicago, Ill.



SANGAMO Accurate Condensers

These condensers are ideal for shortwave equipment. Tested at 2500 and 5000 volts for use in small radio transmitters. For maximum efficiency use these low loss units.

Write for catalog sheet

SANGAMO ELECTRIC CO.
SPRINGFIELD, ILLINOIS



Write today for instructive bulletin.
1756 Wilson Ave.
Chicago, Ill.

Low Range FUSES

INSTRUMENT LITTELFUSES
1/100, 1/8, 1/4, 3/8, 1/2, 3/4, 1, and 2 amps, positively protect meters, radios, amplifiers, etc. Also made in 1000, 5000, and 10,000 volt ranges for broadcast equipment, etc. \$100 Protection Guarantee. There is a distributor near you.
LITTELFUSE LABORATORIES

Send for this

FREE SPEAKER CATALOG

Just issued—list all types, DYNAMIC—MAGNETIC—TRUMPET UNITS—for radios, auto radios, public address, call systems, theatre, etc. Every item a real bargain. New engineering features. The finest at lowest cost. Investigate profit making possibilities in handling the Arlab line. SPEAKER REPAIRS—all types, kinds and makes. Work guaranteed. Prompt money saving service.



Send post card for free catalog

ARLAB MFG. CO. 1254 N. PAULINA ST. CHICAGO, ILLINOIS

★ It's Out!

THE NEW 1934 ARRL

HANDBOOK

Bigger and Better Than Ever

\$1.00 POSTPAID — For Sale By — "RADIO"

IMMEDIATE DELIVERIES

42 A-PRIME MODULATOR AND DRIVER—(Continued from page 25)

issue of "RADIO", we find that for a high level carbon microphone (minus 34 DB) input and 100 watts (42 DB) amplifier output, there is an overall requisite gain of 86 DB. The gain in the 42-800 tube combination is 49, making necessary an additional gain of 37 DB in the voltage amplifier.

Fig. 4 illustrates a complete 42 A prime amplifier which obtains the additional voltage amplification from a 77 tube triode connected and then transformer coupled to the first 42. Fixed bias for the 42's is obtained from a separate rectifier and the normal high voltage winding of the power transformer. Inasmuch as fixed bias is already available, it has been applied to all the tubes in the amplifier.

The method of obtaining fixed bias in the power supply is somewhat unusual. A separate rectifier, type 45, is used for the rectification but instead of a separate bias supply winding, voltage is obtained from the regular high voltage secondary winding. This gives us approximately 370 volts neative to ground which is readily filtered, with a resistance-reactance-capacitance network.

15 MA flows in this bias supply circuit, assuring adequate stability and low impedance. The impedances available on the input transformer are 50, 200, and 500 ohms, and there are also arrangements for more than one line, such as three 500 ohms lines used simultaneously, three 200 ohm lines used simultaneously, or one 500 and one 200 ohm line used simultaneously. If it is desired to use this amplifier for public address work, it is only necessary to replace the A-53 transformer with a type PA-15 transformer, which has secondary impedances of 500, 200, 16, 8, 5, 3, and 1.5 ohms.

Where the driver tubes are a portion of the main amplifier and the Class B tubes are placed with the RF, it is generally desirable

to use a 500 or 200 ohm line between the tubes. It is important in this case that balanced transformers be obtained for the driver output and the class B input. Using the PA-15

output and a type PA-59 input transformer, a perfect line matching combination is obtained effecting no loss in efficiency and quality.

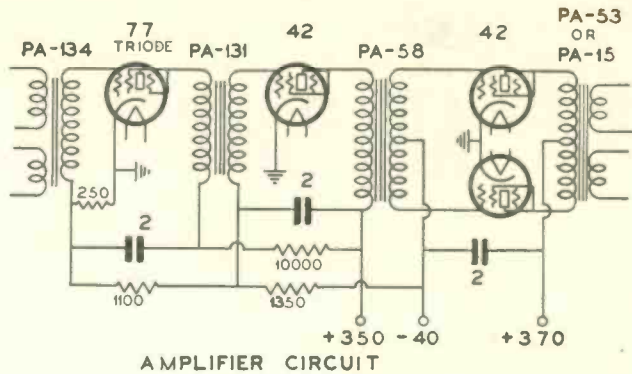

FIG. 3

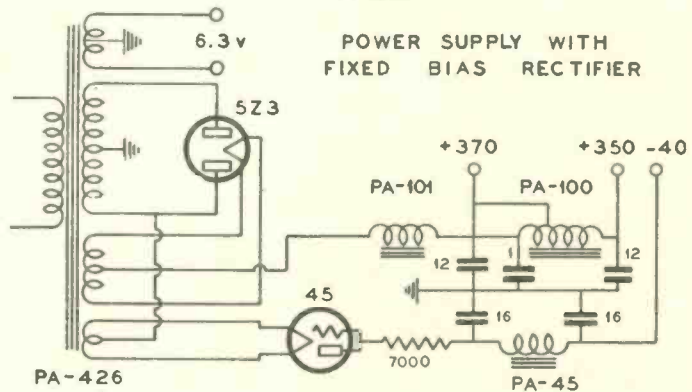

FIG. 4

TUNING CONTROLS

For Radio Set Manufacturers

NEW AIRPLANE TYPES in ten styles

More than fifty kinds shown in our Catalogs

Also escutcheons, cabinets, grilles, nameplates and other specialties

Send for Catalogs

REMOTE CONTROLS

For Auto Radios

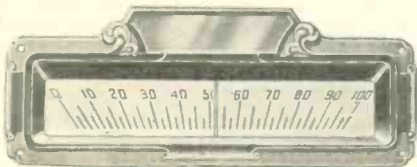

No. 133 2/5 actual size. Ratio 6 to 1 in 180°.

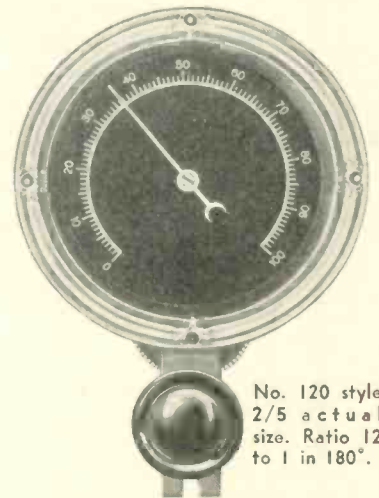
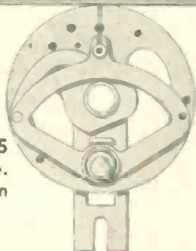

No. 120 style 2/5 actual size. Ratio 12 to 1 in 180°.

EXPORT ORDERS WILL HAVE CAREFUL ATTENTION

Cable Address—CRONAME CHICAGO

Jobbers and Dealers will find our line profitable

Crowe Name Plate & Mfg. Co.

1755 GRACE STREET

CHICAGO, ILL., U. S. A.

Established 35 years

Pacific Coast Representatives, W. BERT KNIGHT, Inc.

HICKOK

New 1934 Model S. G. 4800 ALL PURPOSE RADIO SET TESTER

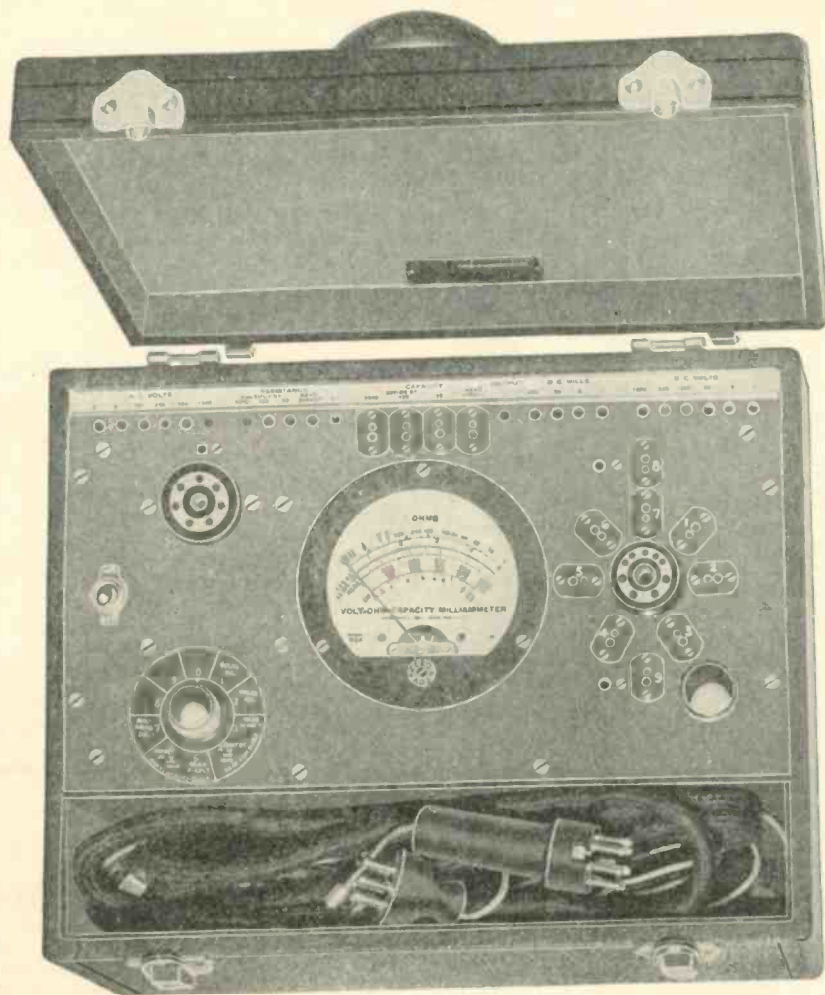

for

Combination
Point to Point
(Static) or Dy-
namic Method

**COMPLETE
COVERAGE**

Lowest to Highest Values

VOLTS, D. C.
VOLTS, A. C.
MILLIAMPERES
RESISTANCE
CAPACITY
OUTPUT

The Multi-Selector unit located on right of tester is designed to enable the user to test sets using all the new type tubes. The Multi-Selector unit enables the operator to make all possible voltage and current measurement combinations and is equal to an 89 point switch.

EXTRA LARGE METER, 4 1/4" DIA. EASY TO READ

READINGS CONTAINED IN METER ON 4800 RADIO SET TESTER

Five ranges of D.C. volts as follows:	0-5 0-50 0-250	0-500 0-1000
Five ranges of A. C. volts as follows:	0-5 0-50 0-250	0-500 0-1000
Four ranges of D. C. Milliamperes, as follows:	0-1 0-5	0-50 0-250
Four ranges of resistance reading from 1/2 ohm to 10 meg-ohms. in four steps as follows:	1/2 ohm to 10,000 ohms 5 ohm to 100,000 ohms 50 ohm to 1 megohm 500 ohm to 10 megohm	
Four capacity ranges, .0001 Microfarad to 20 Microfarads, as follows:	.1 — 20 Microfarads .01 — 2 Microfarads	.001 — .2 Microfarads .0001 — .02 Microfarads

New development in the construction of capacity meter, accuracy is unaffected by any A.C. line voltage between 100 and 125 volts.

New development in the Ohmeter accuracy is absolutely unaffected by change in battery voltage.

Temperature coefficient, all meters, all ranges, practically zero. Output Meter contains complete range of output with sensitivity so that the least sensitivity of volume output can be read.

OUTPUT RANGES

0-5	Volts, Sensitivity 1 Milliampere
0-50	Volts, Sensitivity 1 Milliampere
0-250	Volts, Sensitivity 1 Milliampere

Instructions supplied to enable operator to connect output meter to receiver without disturbing internal connections. Connection is made through tube sockets of receiver.

THE HICKOK ELECTRICAL INSTRUMENT CO.

CLEVELAND, OHIO

Reply to West Coast Representatives

THE PACIFIC SALES CORPORATION

426 LARKIN ST., SAN FRANCISCO, CALIF.

Twice as Big as Before
IS

THE SECOND EDITION of
**KRUSE'S
RADIOPHONE
GUIDE**

- and is just as full of operating and constructional information that isn't found elsewhere.
- And furthermore . . . there's a complete set of

Batcher's 'Radiographs'

the simplest problem-solvers we ever saw.

- At your dealers or Postpaid for 50c (Canada 75c)

ROBERT S. KRUSE, Guilford, Connecticut



"Ah, My dear Watson --"

There's no mystery about the popularity of this new RADIOHM for replacement jobs. You'll detect it at once . . . for it offers smoother, easier, better attenuation than ever before. Try a RADIOHM on that next job.

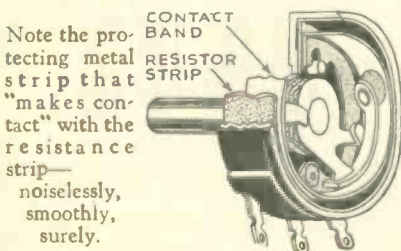

Note the protecting metal strip that "makes contact" with the resistance strip—noiselessly, smoothly, surely.

Centralab

MILWAUKEE, WISCONSIN

RADIOHM

Every Radio Service Man should be a member of the Institute of Radio Service Men

POWERPLATES

Powerplates are Quartz Crystals of maximum power output. They cost no more than other crystals. They are used by commercials, amateurs and government stations.

AL HOEFELICH
626 16TH AVE. SAN FRANCISCO

From Ones To Nines

(Continued from page 22)

W8FMF TELLS US WHAT'S NEW IN "HONEYMOONLAND" (NIAGARA FALLS, N. Y.—YOU LIDI)

The Niagara Amateur Radio Club is active again after several months of hibernation. We think the fellows must have spring fever. Hi.

The Buffalo Amateurs are hot for another hamfest after the swell time they had in Rochester.

W8JE works in conjunction with W3CXL and NY1AB, handling personal traffic for the BYRD EXPEDITION. Joe is also a new ITK member.

W8SF has rebuilt his rig. W8ANQ has a new highpower job on the air. W8AYD worked K6EWQ and VK3DM on successive mornings with 46's in the final stage. W8GWW worked all districts in THREE AND A HALF HOURS on 80 meters and also received a HEARD CARD FROM GERMANY FOR "80". MEIN GOTT EIN HIMMEL! W8DCX is on 20 meters with 500 watts input. W8CJJ is on 40 meters and sez that "DX is fine". W8IGT is on 160 meter phone and says it's fine business when the QRM lets up. (What band isn't!) W8KBS tells us that the fellows around Elmira have a traffic net that WORKS! W8HVE has an 852 on 40 meters. W8IH has moved to eliminate BCL interference. W8KCH operates on 160 meter phone at the tender age of 14—many is the time that the hopeful op at the other end says "Go ahead, YL". Hi.

W8LIM may have a haywire rig, but it shore do make the hay while the sun shines. One of the "boys" down at W8FMF's shack put his foot in the tube drawer and smashed three of the precious bottles. Nice friends! (?) Dust piles high at W8AMZ while he strains the gray matter at M.I.T. The boys along the Niagara river wish someone would watch the BOOTLEG RADIO STATIONS AS WELL AS THE RUM RUNNERS USED TO BE WATCHED.

(W8FMF is in a play, which his school is presenting—tweet, tweet.—Editor).

•••

W9HPK TELLS US OF THE "BOYS" IN THE MID-WEST

W9PSW has at last gotten his ticket. It took him several set-backs to get "her", but he kept trying. Fb.

W9MQJ works everything but DX, hi. W9HPQ has a Rb new 50 watt Hartley rig.—What, no crystal?

Ahhhhh, W9FZH is building a new CRYSTAL rig. W9PEH has some dandy, new and original QSL cards.

W9GXT has finally gotten a job, so it shouldn't be long until he has those long-wished-for parts for his rig.

Most of the amateur radio clubs in the Chicago district are forming a council of representatives from each club to further the interests of the hams in that vicinity. (Ed. Note: This embryonic group can do much to save worry and friction if they will write the Federation of Radio Clubs—c/o Walter Matney, W6EQM, Pres. This is a similar organization which is just beginning to run smoothly).

•••

W9OP GIVES US A FEW STRAIGHT-FORWARD OPINIONS FROM CHICAGO

There has been much gnashing of bicuspids because of the Federal spies, sponsored and abetted by Ham HQ, who park on our freqs and send little blue slips to fellows whose notes show a tendency to become frayed once in a while. W9CNO got one of these recently and split a thousand infinitives . . . his note sounded perfect to your scrivener when we tseted . . . so we concluded that the spy had his receiver oscillating something awful to turn him in . . . why, if we must put up with this elaborate spy system, don't the Hartford harrangers tell them that certain stations in the ham spectrum are recognized as decent layouts and will not be apt to put out bum sigs. . . we note that the guileless kids with squeaky and squawky notes are still doing business at the old stands, much more annoying to traffic-fellows than a good, clean RAC crystal rig that can be tuned out . . . yowsah, us Chicagoans feel that the Hartford Gohenzollerns have made a big mistake by asking for this self-inflicted restriction, and if they are "right" fellows, they will admit their mistake and take a flying trip to Washington and straighten themselves out . . . if not, we'll back "RADIO" until they do something about it. That's about all for this apasm . . . but we will keep an ear to the earth and see you again next issue. (Ed. Note: What do our readers think of the protest by W9OP and others back there in the Middle West? Let's have your opinions—write this department).

•••

Complete Kits

All parts needed for "The Gainer," as described in Feb. "RADIO," \$9.85.
TECHRAD, 260 Castro St., San Francisco

A Mixer Monitor

(Continued from page 11)

tenna or feeder current does increase up to 22 per cent under the same conditions.

Since the monitor detector circuit is linear and does not have frequency discrimination to any extent, it gives an accurate playback of the phone signals exactly as others would hear them on the air. The coupling required between the monitor and the transmitter does not react on the latter to any extent even on small 46 or 59 layouts.

Taken all in all, the mixer monitor makes a handy little gadget for amateur operators, both prospective and present.

SPECIAL!

Heavy, Rugged Steel Cabinets,
7 x 10 x 6

Finished in black crystalline; hinged top, removable chassis, exact size cabinet for completely shielding your "Gainer" or other receiver.

ONLY \$1.95

This same steel cabinet can be used for housing power supplies, oscillators, monitors, etc., etc.

ORDER ONE TODAY!

You Will Be Greatly Pleased

R. H. LYNCH

970 Camulos St., Los Angeles, Calif.

RADIO for 1934

SERVICEMAN YOU SET BUILDER NEED DEALER THIS BOOK

ALWAYS ON THE JOB

You can handle any Radio Service problem without delay or worry when you are working hand in hand with your ALLIED Catalog. It's a "cinch" . . . because this

book is the most valuable in radio . . . packed with Quality and VALUE, bringing you the greatest selection of parts and accessories for every conceivable radio service job. Your 1934 ALLIED Catalog is ready . . . write for it today. It's packed with complete parts, listings, latest



FREE

Set-Building Kits and Free diagrams, Long and Short Wave Sets, New Sound Systems, the biggest selection of Test Instruments . . . all at the lowest wholesale prices.

ALLIED RADIO CORP.

833 W. Jackson Blvd., Dept. J.
Chicago, Illinois.

Please send me FREE your New 1934 Radio Book.

Name

Address

City State

Allied Radio

NEW ALDEN PARTS

705SWS BAND SPREAD S-W COILS



Simplifies tuning by spreading out the S.W. bands. Secondaries tapped for most efficient operation. May be easily substituted for the 704 SWS Coils. Precision wound on beautiful new improved forms. Coils have UY bases.

705SWS Band Spread S.W. Coils. List pr. \$2.50 Set.

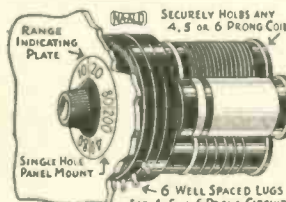

New No. 700 S.W. Coil Selector Unit instantly swings any coil into circuit by turning knob. All 4, 5 and 6 prong coils are rigidly held by the specially constructed sockets without

6 WELL SPACED LUGS FOR 4, 5 OR 6 PRONG COILS. Adjustments of any kind. Knob and indicator on face of panel show which coil is in circuit. Simple—compact—rugged—electrically efficient. Don't fail to use it in sets you are building and new equipment you are designing.

No. 700 COIL SELECTOR UNIT without coils. List Price \$3.50

Precision wound coils with the convenient gripping-ring for easy insertion and removal from socket.



704SWS

706SWS



706BCS

704SWS Set of 4 coils; 10-200 meters; 2-circuit List \$2.00

706SWS Set of 4 coils; 10-200 meters; 3-circuit List \$3.50

704BCS Set of 2 coils; 100-550 meters, matches above List \$1.50

706BCS Set of 2 coils; 100-550 meters; matches above List \$2.00

Color coded easy-grip ring coil forms, 1 1/4" diam. x 2" winding space. No. 704 4-prong coil form, No. 705 5-prong coil form—List 25c Each. No. 706 6-prong coil form—List 30c Each.



950XYLA List \$6
Checks over 120 new tubes including the small sevens in your present tube checker. If checker has no fl. voltage switch, adapter 954-SGL, list \$1.25, is also required.

Servicemen's discount 35%; on orders listing \$10 or more, 40%



950TR List \$6
Checks ALL 10 to 30 volt filament tubes in the 24 tube checker socket. Has internal transformer and filament voltage selector.

Send two 3c stamps for NEW CATALOG-DATA BOOKLET showing socket diagrams of over 265 different tubes, analyzer rewiring data, new tube replacement data, sockets of all kinds, coils, forms, adapters, kits, diagrams for rewiring tube checkers, etc.



ALDEN PRODUCTS CO.

Dept. RO-3, 715 Center St. BROCKTON, MASS.

100 VOLT A C POWER FROM AUTO GENERATORS

This unusual book, complete with drawings and illustrations, tells you how to easily change Ford, Chevrolet, or Dodge generators, and produce 32 to 110 volts, A C or D C. Gives power for radio testing, shop tool operation, floodlights, etc. Price only \$1. Autopower, 410-A So. Hoynes Ave., Chicago.

NOTICE! You can get the next 4 issues of "RADIO" for \$1.00. Subscribe NOW!

FORMS CLOSE ON THE 10th OF MONTH

RATES 10¢ PER WORD PAYABLE IN ADVANCE

CLASSIFIED RADIOADS

NOTICE! Those who wish to advertise in these RADIOADS columns and who do not desire to divulge their names and addresses can use BOX NUMBERS, and all inquiries will be mailed, unopened, to the advertisers.

THE SHORT-WAVE MANUAL, by W6AAM. Over 300 circuits and sketches. Low-power grid modulated phone circuit. Complete data for building modern equipment, \$1.00 postpaid. Don C. Wallace, 4214 Country Club Drive, Long Beach, Calif.

BARGAINS: FIVE KILOWATT water cooled tube, practically new, guaranteed, \$90.00. Commercial Shortwave receiver, RCA Model AR-1496-D, licensed for commercial use, cost about \$350.00. SPECIAL \$110.00. Motorgenerators, DC and 500 cycles AC very cheap, sizes to 2 kilowatt, 1000, 1500 and 2000 volts DC. Navy SE 143, 250 to 7500 meter receivers, with audio controls, used but OK, \$25.00. Power transformers; 1 KVA, pole transformer, 2200 secondary, \$12.50 2 K.W. 3300, 4400 or 6600 volts, \$20.00; RCA plate and filament supply, \$15.00; 3000 volts, center-tapped with 2 sets filament windings. Several large rectifier tubes, suitable for high powered amateur job, cheap. National SW5, short wave AC operated receiver, with power supply unit, and full set coils, good as new—not a mark on it, \$35.00, complete with tubes and WE cone speaker. Five kilowatt 120 volt General Electric DC generator, direct connected to General Electric 4 cylinder gas engine. Fine for remote power supply system. Original cost about \$1800.00, no reasonable offer refused. (This unit F.O.B. San Jose, Calif.) Honeycomb coil receivers, with 2 stage audio amplifiers, some coils included, \$5.00 each. Navy CW 936 and Signal Corps SCR 67 Western Electric Radio Telephone sets, \$25.00, used, but would make fine amateur 160 meter jobs, with slight changes. (No power supply or tubes included) Poulsen Telegraphone, (steel wire electrical sound recording machine) \$75.00, used. 2 kilowatt Poulsen Arc, (arc only) used but operative, \$50.00. Bodine 78 RPM 12-in. phonograph turntable, Stromberg-Carlson magnetic pick-up, included, \$5.00, first class condition. D. B. McGown, 1247 - 47th Ave., San Francisco, Cal.

THE SIMPLE electron-coupled MOPA transmitter described in this issue of "RADIO" is offered for sale by the constructor. Complete with 80 meter coils on Hammarlund Isolantite forms. Hammarlund condensers used throughout. Ohmite resistors. This is the original laboratory model, complete as per photograph. Price, with tubes, \$18.50. Reason for selling: no further need for same. Only one available. First check takes it. Clayton F. Bane, 260 Castro Street, San Francisco, Calif.

FREE—Latest Call Book, year subscription to "RADIO" or R/9 with every receiver. McMURDO-SILVER 5B Superheterodyne, complete with tubes, speaker, \$59.70; with crystal, \$68.70. Sky-Rider, Patterson PR-10, Postal International, Sargent 9-33, others. Transportation allowance. Why pay western prices? "MARINE" Crystals. Guaranteed 40-80-160 band within 10 KC. \$2.45; 80-160 band exact, \$3.45. Catalogs. L. I. MARINE & ELECTRIC CO., 163-18R Jamaica Ave., Jamaica, N. Y.

TRANSFORMERS—350 watts, 750-1000 each side, \$10.00. 450 watts, 1000-1500 each side, \$12.00. Quotations given. Frank Greben, W9CES. Accurate Radio Service, 2920 W. Cermak Road, Chicago, Ill. Phone Crawford 2050.

RARE BARGAIN! for transmitting hams. Over \$3,000.00 worth of new equipment to build highest power transmitter anybody would want. Must be sacrificed for give-away price. Send for complete list, to D.D.L.C., c/o Box No. 101, "RADIO", Pacific Bldg., San Francisco, Calif.

866's—1000 HOUR GUARANTEE—Heavy duty, \$1.75, postpaid in the U. S., Canada and Mexico, \$1.75. HOWARD TUBES, 314 Pine Ave., Chicago, Illinois.

NEW 1934 ARRL HANDBOOK. Get this new book by subscribing to "RADIO" for 6 months. Total cost, Handbook and subscription, \$1.95. "RADIO", San Francisco, Calif.

"WANTED" OLD RADIO MAGAZINES, ALSO ENGINEERING SUBJECTS. WRITE LIST AND PRICE. Jacques A. Kurtz, 100 E. 18th Street, Brooklyn, N. Y.

Back copies of "RADIO". Few only available. 25c each, postpaid. Edw. J. Byrne, 253 West 128th St., New York, N. Y.

NOTICE! Large blueprints and complete constructional data on four different five meter phone transmitters and trans-clevers can be had for 85c postpaid. Order from Albert Freeman, South Hanson, Mass.

DELFT

Send 10 cents in stamps or coin for catalog listing a fine, new line of short-wave and ultra-short-wave two-tube sets, three-tube sets, four-tube sets, wave-meters, RF porcelain chokes, special short-wave coils and a large stock of other short-wave parts.

Dealers and Distributors Wanted



DELFT RADIO MFG. CO.
524 FAIRBANKS AVE., OAKLAND, CAL.

SHALLCROSS WHEATSTONE BRIDGE

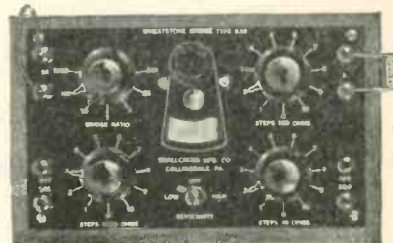

Built around a highly sensitive galvanometer and Shallcross Resistors. Range .01 ohms to 11.1 Megohms.

Send for Bulletin 630-B describing this instrument

SHALLCROSS MFG. CO.
COLLINGDALE, PENNA.



QUALITY APPARATUS FOR Short Waves

GEN-WIN SHORT WAVE COIL KIT

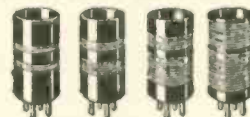

These coils are considered the finest made. Each coil is precision wound on a different colored bakelite form for quick identification of wave lengths. Used and highly recommended by all short wave experts. Range (16 to 225) meters, using .00014 or .00015 mfd. condenser. Recommended for the following sets: "The Globe Trustee", "The Overseas", "The Dierling 12,500 Mite Two Tube Receiver and Doerle Three Tube Signal Gripper", "The Needyne".

4 Coil Enamel Wire Kit \$1.50
4 Coil Litz Wire Kit \$2.25
Broadcast Coil. (200 to 550 meters) \$5c

POLICE AND SHORT WAVE ADAPTER \$1.50
ALL-WAVE COIL KIT Range 25 to 550 Meters \$5.00

Convert your broadcast set into a shortwave set tuning from 30 to 200 meters. Complete a precision wound tuner and it. 7 coils both having tapered sections on dials, which permits you to enjoy both SHORT WAVE and BROADCAST P.W. GRAMS. If you own an Ambassador or any other three circuit tuner receiver, you can easily convert the set into an all wave receiver by replacing the coils with these new GEN-WIN ALL-WAVE coils. Coils may be had for use with either .00035 or .0005 Mfd. condenser. Specify which when ordering. Wiring diagram included free with coils. Separately 10c.

Get exciting police alarms from stations thousands of miles away. Airplane communication while in flight. A man to your phone and international code communications. The biggest thrill and fun for so little money. Installed in a jiffy. Plug directly into the detector tube sockets. Specify the detector tube in your set, or if uncertain as to detector tube, advise make and model number of set when ordering.

No. 200—for '27, '37 \$1.39
and '56 Det. tube—\$1.39
No. 201—for '24, '35, and '36 Det. \$1.39
tube

All Wave Tuner (as illustrated) \$90
All Wave R. F. Coll. \$75

Send remittance in check or money order. Register letter if it contains currency.
GENERAL WINDING COMPANY
254 W 31st St. NEW YORK, N. Y.



McMURDO-SILVER

5B SUPER . . . choice of those who know!

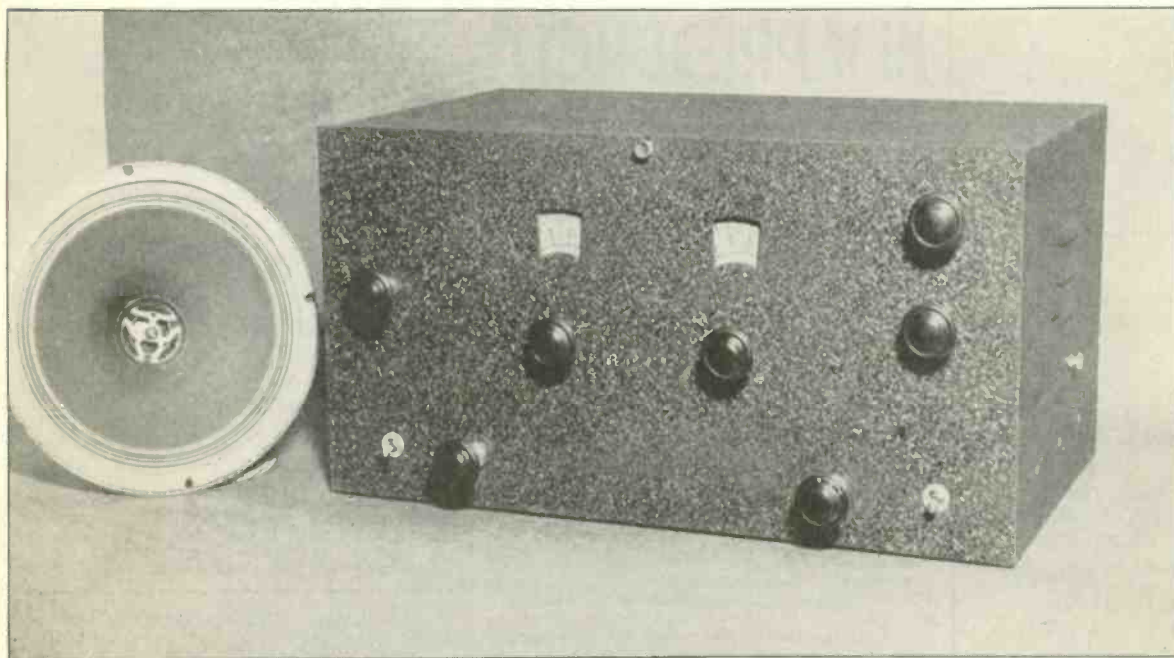

From a western publisher comes the following comments as a result of test and operation by Colonel Clair Foster (W6-HM) on the new 5B Single Signal Super:

"Colonel Foster liked that 5B so well that, when KAILG asked him what super was best to buy, the Colonel told him to buy the 5B."

Among many other enthusiastic comments from users of the 5B the following from Mr. L. P. Stowe, W4CEI, is representative:

"Your 5B receiver set up here last week and working very fine; the more I use it the better I like it. I was interested in the receiver only as a ham receiver and it's the best set that has ever been my privilege to operate, both on phone and on CW. The selectivity on phone is almost unbelievable with the xtal in the parallel position, and on code the variable pitch OSC and the S.S. xtal filter makes solid copy more the rule than the exception."

SEND 3c

stamp for new complete catalog describing above items, E. C. Frequency Meters, New Airplane Dials, Relay Racks, RF Chokes, Audio, Power and Filter Transformers, and a host of new and interesting amateur and commercial apparatus.

- SPECIFICATIONS -

Circuit—Eight-tube superheterodyne.
 Tubes—'58 tuned RF, 2A7 1st detector—E.C. oscillator, two '58 tuned IFS, '58 audio beat oscillator, '56 second detector, '59 output, 5Z3 rectifier.
 Range—1550 to 30,000 KC—five amateur bands on 1 dial.
 Tuning—One main illuminated vernier tuning dial, smooth and easy, directly calibrated in megacycles. Band spread tuning anywhere in range—amateur, broadcast, commercial. 100 degree band spread 20 and 40 meters—200 degree spread 80 and 160 meters.
 Wave Length Change—Same, positive, 6-gang wave change switch approved by Admiral Byrd and used in his four MASTERPIECE IIs.
 IF Amplifier—Dual air tuned, Litz wire . . . 465 KC.
 Beat Oscillator—Electron coupled '58. Beat note pitch adjustable from front panel.
 Sensitivity—Better than one microvolt absolute.
 Selectivity—Circuit designed,

built and adjusted for crystal resonator, without crystal, band width 21 KC 10,000 times down. With crystal, absolute single signal (50 cycles wide).
 Power Output—3 watts undistorted. Supplied complete with Jensen dynamic speaker, and head phone jack on front panel.
 Shielding—100% perfect, all parts individually shielded. Overall cabinet shield easily removable with 6 thumb nuts.

Price \$59.70

net to amateurs with eight guaranteed and tested Raytheon tubes. Each set complete with selectivity control, crystal switch, phasing condenser and crystal socket—ready for insertion of crystal. Add to above price \$9 net for Bliley crystal with holder, and complete crystal alignment—complete price, ready to go single signal with crystal, \$68.70.

McMURDO-SILVER, INC.

1741 BELMONT AVE. CHICAGO, U. S. A.

Radio Dealers and Jobbers who desire to advertise in these columns are invited to write for rates.

RADIO BUYERS' GUIDE

A Monthly Listing of Reliable Radio Dealers and Jobbers who solicit the patronage of our readers. Buy from your nearest Dealer or Distributor. He is dependable and reliable.

CHICAGO, ILLINOIS

Chicago Radio Apparatus Company, Inc.

415 South Dearborn Street
Harrison 2276

Dependable Radio Equipment
Established 1921

Bulletins on request—we specialize in short wave transmitting and receiving apparatus.
Catalog Ten cents.

CHICAGO, ILLINOIS

MID-WEST RADIO MART

520 South State Street
CHICAGO

Write for Special Catalog—Free

CHICAGO, ILLINOIS

Newark Electric Company

226 W. Madison St.
Chicago

All Kinds of Equipment for
Service Men - Amateurs - Experimenters
Write for free catalog

OAKLAND, CALIFORNIA RADIO SUPPLY CO.

2085 BROADWAY.

New 2-Tube Sargent DX-Ranger Kit,
\$12.50 complete.

New Sargent 9-33 Superheterodyne,
\$69.50, net, less tubes.

Sargent Short-Wave Sets and Kits.
Write for Circulars.

SEATTLE, WASHINGTON



SEATTLE RADIO SUPPLY
INCORPORATED

8319 SECOND AVENUE SEATTLE, WASHINGTON

LARGEST PARTS SUPPLY DEPOT IN THE NORTHWEST

Four of Our Employees Are Licensed
Amateurs

DISTRIBUTORS

DUBILIER-WARD LEONARD
CARDWELL-RCA TRANSMITTING TUBES
WESTINGHOUSE METERS

DUBILIER CONDENSERS

1 MFD, 400 VOLTS.....	25c
2 MFD, 400 VOLTS.....	30c
6 MFD, 700 VOLTS.....	75c
6 MFD, 900 VOLTS.....	95c
0.25 MFD, 1000 VOLTS.....	30c

WESTON METERS

0-50; 0-100; 0-200; 0-300; 0-500..... \$3.75
0-1 MA, in Bakelite Case..... \$5.40

Meters in Limited Quantity

Service-Man's Condenser Kit,
25 condensers, 0.1 to 2 mfd..... \$3.45

POWER TRANSFORMER for Transmitters,
1200 V. C.T. Secondary, 2-7½ V, 1-2½ V,
150 MA..... \$4.50

KAY'S RADIO

Dept. RM
179 Greenwich Street, New York, N. Y.



NEW PRODUCTS

Sprague 1000 and 2000 Volt Transmitting Condenser At Low Prices

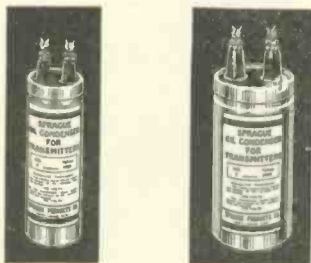

SPRAGUE Transmitting Condensers are made of a special process paper which is impregnated with a mineral oil and then again immersed in oil so that it will freely circulate through the capacitor. The circulation of this oil enables the condenser to radiate any heat which might be generated inside of the condenser. The cylindrical winding used helps in this direction.

With the exception of the excess oil used in these condensers, the construction and the material used in Sprague transmitting condensers is very similar to those used in the construction of high voltage cables. Readers no doubt are familiar with the high voltage cables which carry from 10,000 to 100,000 volts.

Because of this similarity in construction, Sprague condenser will stand a very high overload even though they are conservatively rated. Sprague oil condensers are not self healing due to the fact that it is not necessary because of the large safety factor found in these units.

Smallest "B" Unit Packs Plenty of Power

THE smallest Rotary type "B" Battery Eliminator ever designed with full power output is now being placed on the market by the CARTER MOTOR COMPANY, 361 West Superior St., Chicago. It is only 2¾-in. wide x 4-in. high x 5-in. long, and weighs only 6½ pounds. Being so compact and light in weight, it can be easily placed in either the radio set or speaker case. The unit is completely enclosed and shielded and requires no adjustments whatever. It is priced at \$16.50.

The new type thrust ball-bearings used do not require oiling, and permit the unit to operate at highest efficiency in any position.

The unit consists of a newly designed motor generator with a reflex filter circuit and operates from a 6 volt storage battery delivering up to 350 volts.

When used as an Auto "B" Battery Eliminator separate filters and chokes are not required as the new Reflex filter system uses the motor field coil for part of the filter.

This "Pocket" edition is ideal for Auto Radio, Aeroplane transmitters, and receivers, farm battery sets, portable sound equipment, and many other uses due to its small size and light weight.

The new CARTER GENEMOTORS can be supplied for both AC and DC output up to 500 volts, and also are made to operate from 32 volt farm lighting plants.

The Chicago Police Department, after a year and a half of constant service tests, are now equipping 250 squad cars with CARTER GENEMOTORS.

CHICAGO, ILLINOIS

Chicago Radio Apparatus Company, Inc.

415 South Dearborn Street
Harrison 2276

Dependable Radio Equipment
Established 1921

Bulletins on request—we specialize in short wave transmitting and receiving apparatus.
Catalog Ten cents.

PITTSBURGH, PENNSYLVANIA

CAMERADIO COMPANY

603 Grant Street

Tri-State "Ham" Headquarters
Standard Apparatus Standard Discounts

FRESNO, CALIFORNIA

PORTS MANUFACTURING CO.

3265 E. Belmont Ave. Radio W6AVV
National FB7-SW3 and Parts; Hammarlund,
Cardwell, Bliley Crystals; Johnson Insulators.
Complete Stock --- Write for the Dope
Established 1914 Leading Ham Supply Store

SAN FRANCISCO, CALIFORNIA



1452 Market Street.

"The House of a Million Radio Parts"

Hammarlund and National sets and parts.
RCA-DeForest Amateur Transmitting Tubes.

Collins Transmitters.

Arcturus Receiving Tubes.

Trimm Phones, all types.

Johnson Antenna Feeders, Insulators,
Transposition Blocks.

ST. PAUL, MINNESOTA

LEW BONN COMPANY

2484 University Avenue

Rex L. Munger, W9LIP, Sales Engineer

Radio Wholesaler

Complete Stock

KANSAS CITY, MISSOURI

Burstein-Applebee Company

1012-14 McGee Street

"Specialists" in supplies for the Amateur and Serviceman

CROSLEY

Sweeps Country With

Streamline Beauty

Ventilated Front

This feature of all Crosley models draws cool air from the front and expels warm air from the rear, properly ventilating power unit even when refrigerator is placed in limited space or close to wall.

IN THE NEW SERIES



\$99⁵⁰

MODEL EA-35

This Crosley Shelvador has a NET capacity of 3.5 cubic feet with a shelf area of 7.5 square feet. It is equipped with two 21-cube ice trays—42 cubes in all. It incorporates all of the Shelvador Series features described to the right. Dimensions: 48¹/₄" high, 23³/₄" wide, 24¹/₄" deep.

... plus greatly increased "usable" storage capacity

ALL of the new Crosley models—both Shelvador Series and Tri-Shelvador Series—feature the now famous Shelvador. When the Shelvador—an exclusive and patented Crosley feature—was first presented to the American housewife over a year ago, it created the greatest sensation in the history of home electric refrigeration.

Increases "Usable" Capacity About 50%

Shelvador increases the "usable" food storage space about 50%. It provides a definite place for small items. As an example: in the Shelvador, an orange occupies exactly the space that an orange should—not the space of a bottle of milk.

Now Comes "Streamline Beauty"

All of these new Crosley Shelvador and Tri-Shelvador models are streamlined. They fulfill the dream of every woman for a refrigerator that does justice to her home, her kitchen, and can be a daily source of pride—can be "lived with" as well ten years from now as today.

Compare These Features

First comes Shelvador, then the ventilated front, automatically illuminated interior, no-stop defrosting control (defrosts while refrigerator is operating), chromium plated stamped brass hardware of modern design, thorough insulation throughout (including door), round cornered porcelain interior, white lacquer exterior with black trimming, ample tray capacity for quick freezing of ice cubes.



Model EA-43

4.3 cu. ft. NET capacity, 9.15 sq. ft. shelf area, 2 ice trays—42 cubes—one double depth tray.

\$117.00



Model EA-55

5.5 cu. ft. NET capacity, 11.6 sq. ft. shelf area, 3 ice trays—63 cubes—one double depth tray.

\$145.00

ALL MODELS HAVE AUTOMATICALLY ILLUMINATED INTERIOR

ADDS THREE ADDITIONAL EXCLUSIVE FEATURES TO THE FAMOUS SHELVADOR



IN addition to all of the outstanding features of the Crosley Shelvador Series described above, the Crosley Tri-Shelvador Series incorporates three additional features never before combined in a home electric refrigerator.

1—THE SHELVATRAY . . . When you want to hide the chicken, merely drop Shelvatray in position, place the chicken on it and get on. Shelvatray (patent pending), an exclusive Crosley feature, saves both steps and stoops.

2—THE SHELVABASKET . . . Hangs in front of the refrigerator. Holds carrots, cabbages, canned goods and other produce. Exclusive Crosley feature. Swings open and closed. Shelvabasket is automatically illuminated. (Patent pending.)





UTC engineers now present a NEW amplifier layout for an A PRIME 18 Watt power amplifier to drive Class B 800's, 242A's, 211E's, or 210's.

Uses new 6 volt heater tubes.

The amplifier may be used either complete for public address applications or to drive a final Class B modulator stage.

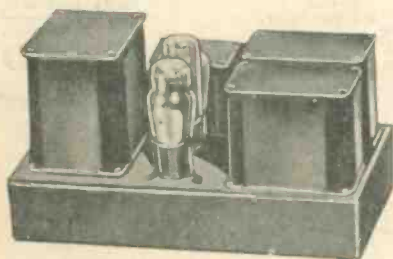
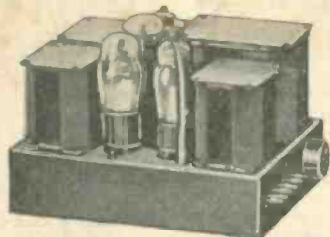

- Employs new circuit features.
- Three audio stages. Tubes used: 1—77 triode connected, 1—42 triode connected, 2—42's in A Prime.
- Stable fixed C bias for all audio stages.
- Two rectifier tubes: 1—83 for plate supply, 1—71A for C bias supply.
- Input of amplifier will match 50, 200, or 500 ohm lines.
- Audio and power sections on separate heavy gauge drilled metal decks.
- Completed sections may be used either for vertical rack mounting or installed in portable oak cases.
- UTC PA type components used are:

	List price
1—PA-134—50, 200, or 500 ohm line to single grid	\$6.50
1—PA-131—Single 77 plate to single 42 grid	4.50
1—PA-58—Single 42 plate to 2—42 grids	5.50
1—PA-15—Push-pull 42 plates to 500, 200, 16, 8, 5, 3 & 1.5 ohms	7.00
1—PA-53—Push-pull 42 plates to two 800 grids	7.00
1—PA-101—Swinging choke	7.00
1—PA-102—Swinging choke	7.00

A NEW POPULAR PRICED TRANSMITTING LINE CLASS B AUDIO AND FILTER COMPONENTS

Outstanding in Performance . . . Smartly Professional in Appearance . . . Developed for and Used by Commercial Telephone, Telegraph, Communication and Broadcast Systems . . . BUT NOW AVAILABLE TO THE HAM AT PRICES HE CAN AFFORD TO PAY.

SPECIFICATIONS

Class B audio and filter coils are fully shielded in symmetrically housed cases and when grouped in finished equipment, present a thoroughly professional appearance. PA type cases may be mounted with terminals on top or below the chassis. All audio, filter and power components are fully impregnated and then sealed in their cases with a special heat dissipating compound. Exclusive UTC lugs and ceramic bushings designed for positive, non-failing contact.

UTS CASE



PA CASE



UTO CASE

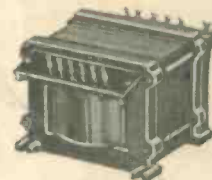

WHY UTC CLASS B AUDIO TRANSFORMERS ARE BETTER

All units are designed to operate at maximum efficiency, and designs have actually been developed and proven in operating circuits.

All coils are accurately balanced and multiply interleaved.

Intelligent sectionalizing of windings and proper impedance relationships reduce losses in both frequency and efficiency.

Selected core materials are operated at proper flux densities to keep out harmonic distortion other than that incident with Class B tubes.

INPUT DRIVER TRANSFORMERS TO CLASS B GRIDS

Type	PURPOSE	List price	Case #
PA-50	Driver plate to 49, 53, 79 or 89 grids	\$5.50	PA-1
PA-51	Driver 46 or 59 plate to 46 or 59 grids	5.50	PA-1
PA-52	Push-pull 45 or 59 plates to 2-46 or 2-59 grids or push-pull 2A3 plates to 2-841 grids	6.50	PA-2
PA-53	Push-pull 42, 45, 50 or 59 plates to 2-242A's, 2-800's, 2-830's, 2-RK-18's, or 2-210 grids	7.50	PA-2
PA-54	Push-pull 2A3 plates to 2-203A grids	8.50	PA-2
PA-55	500, 200 or 50 ohm line to 2-46 or 2-59 grids	7.50	PA-2
PA-56	500, 200 or 50 ohm line to 2-203A grids	10.00	PA-2
PA-57	Push-pull 2A3 plates to 2-830B's, 2-800, 2RK-18 or 2-210 grids	7.50	PA-2
PA-58	Driver 2A5 or 42 triode plate to 2-A Prime, 2A5 or 42 grids	5.50	PA-1
PA-59	500, 200 or 50 ohm line to 2-830B, 2-800, 2 RK-18 or 2-210 grids	7.50	PA-2

CLASS B OUTPUT TRANSFORMERS TO RF LOAD

Type	Primary Load Impedance	Will Match	Secondary Load Impedance	List price	Case #
PA-20	10,000 ohms plate to plate or 6,000 ohms plate to plate	For 10,000 ohms, class B, 49's, 53's, 79's, 89's; for 6,000 ohms, class B, 46's, 59's	5,000, 3,500 ohms	\$7.00	PA-2
PA-71	6,000 ohms plate to plate	Class B, 46, 59's	14,000, 3,500 ohms	7.00	PA-2
PA-70	8,000 ohms plate to plate	A Prime, 42's	5,000, 3,500 ohms	7.00	PA-2
PA-60	6,000 ohms plate to plate	Class B, 203's	3,000, 2,500 ohms	30.00	PA-4
PA-62	10,000 ohms plate to plate or 6,000 ohms plate to plate	Class B, 203's, 830B's	10,000, 2,500 ohms	32.50	PA-4
PA-80	12,500 ohms plate to plate	Class B, 800's, RK-18's	5,000, 3,000 ohms	20.00	PA-4
PA-82	12,500 ohms plate to plate or 8,000 ohms plate to plate	For 12,500 ohms, class B, 800's, RK-18's; for 8,000 ohms, class B, 242A's, 211E's	20,000, 5,000 ohms	25.00	PA-4
	8,000 ohms plate to plate	Class B, 210's, 830's, 841's	18,000, 4,500 ohms	12.50	PA-3

CLASS B INPUT SWINGING CHOKES*

Inductance	Operating Action	Current Range	Maximum DC Oper. Voltage	Ohmic DC Resistance	List price
1000		15 to 150 MA	450		5.50
2000		20	600		5.50
3000		25	1300		5.50
4000		25	1600		5.50